

Feedback in Wireless Networks

Recent Results and Discoveries

Vince Poor
(poor@princeton.edu)

Joint work with Ravi Tandon, et al.

Supported in part by the AFOSR under MURI Grant W911NF-11-1-0036.

Outline

- Background
 - ✘ Point-to-point channels
 - ✘ Multi-terminal channels
- Static Interference Channels
 - ✘ Why feedback helps
 - ✘ Feedback gain for many-user interference channels
- Fading MISO Broadcast Channels
 - ✘ The effects of channel state feedback
 - ✘ Spatio-temporal variation in channel state feedback

Outline

- **Background**
 - ✘ Point-to-point channels
 - ✘ Multi-terminal channels
- **Static Interference Channels**
 - ✘ Why feedback helps
 - ✘ Feedback gain for many-user interference channels
- **Fading MISO Broadcast Channels**
 - ✘ The effects of channel state feedback
 - ✘ Spatio-temporal variation in channel state feedback

Background: Point-to-Point Channels

- Infinite blocklengths:

- ✖ Feedback does not increase capacity (Shannon, IT' 56)
- ✖ But, feedback can speed-up the convergence of the error probability to zero (Schalkwijk-Kailath, IT' 66)

- Finite blocklengths:

- ✖ Feedback can dramatically improve the maximal achievable rate (Polyanskiy-Poor-Verdu, IT' 11)

Background: Multi-terminal Channels

- Feedback does increase capacity; e.g. (among many others):
 - ✘ Multiple-access channels (Gaarder-Wolf, IT' 75)
 - ✘ Broadcast channels (Ozarow & Leung-Yan-Cheong, IT' 84)
 - ✘ Wiretap channels (Leung-Yan-Cheong, PhD Thesis' 76)
 - ✘ Relay channels (Willems-Van der Meulen, IT' 83)

Outline

- Background
 - ✘ Point-to-point channels
 - ✘ Multi-terminal channels
- **Static Interference Channels**
 - ✘ Why feedback helps
 - ✘ Feedback gain for many-user interference channels
- **Fading MISO Broadcast Channels**
 - ✘ The effects of channel state feedback
 - ✘ Spatio-temporal variation in channel state feedback

Interference in Wireless Networks

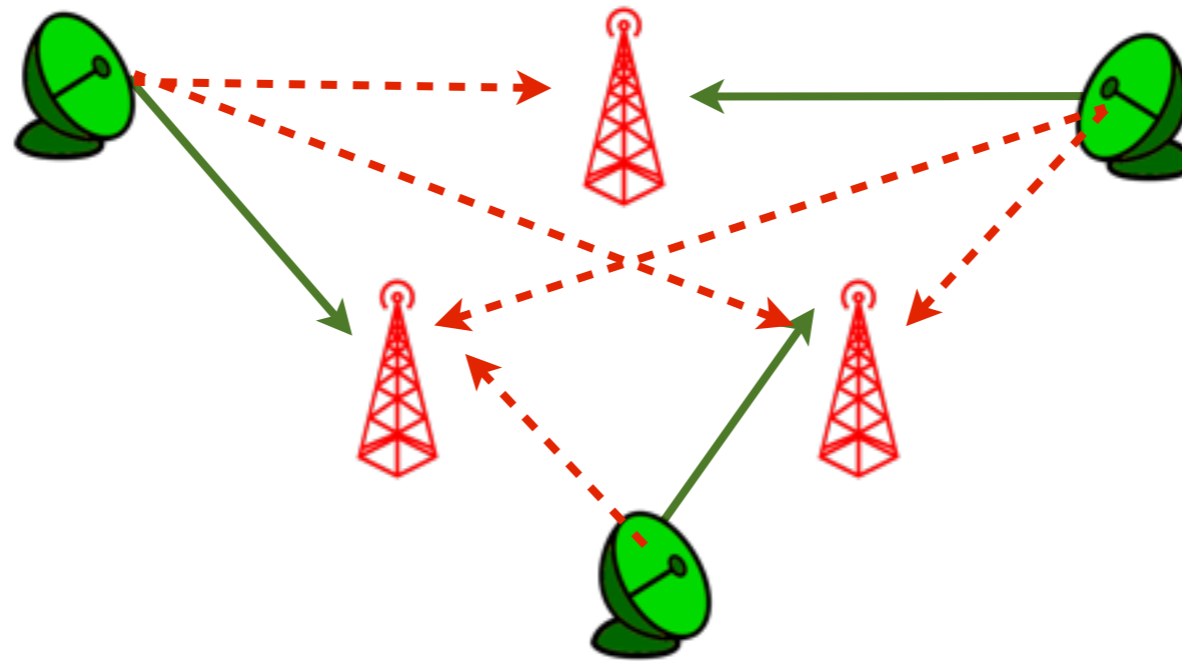

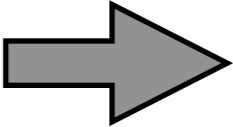
- ▶ Broadcast nature of wireless medium
- ▶ Spectrum reuse  interference is **unavoidable**
- ▶ Fundamental barrier to spectral efficiency

Two-User Gaussian Interference Channel

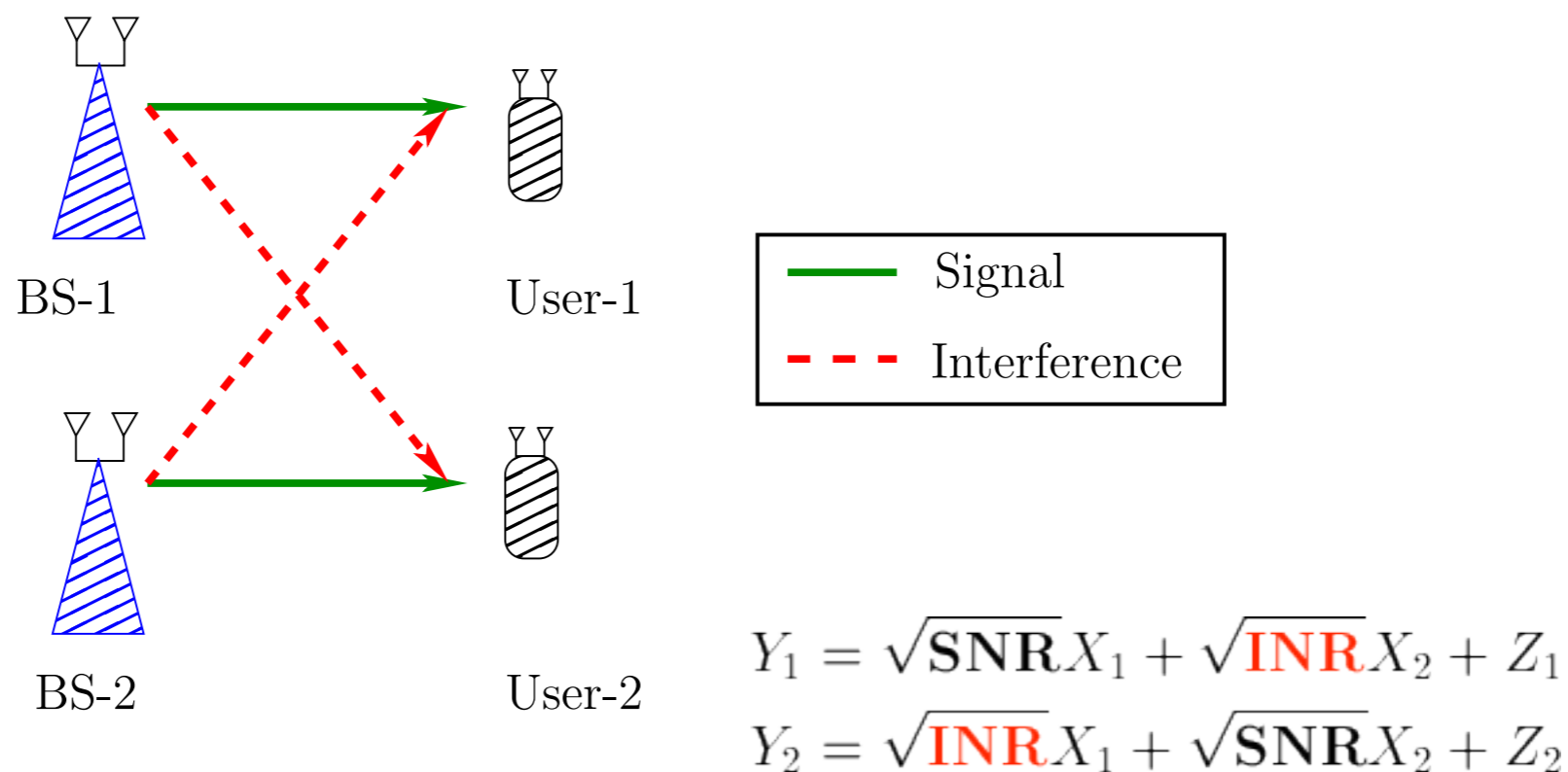

- ▶ Canonical model for interfering users
- ▶ Static setting: SNR, **INR** fixed throughout communication
- ▶ Capacity region is **unknown**

Degrees of Freedom

Point-to-Point AWGN Channel

$$Y = \sqrt{\text{SNR}}X + N \quad \mathbb{E}[X^2] \leq 1, \quad N \sim \mathcal{N}(0, 1)$$

$$C = \frac{1}{2} \log(1 + \text{SNR})$$

$$\begin{aligned} \text{DoF} &= \lim_{\text{SNR} \rightarrow \infty} \frac{C}{\frac{1}{2} \log(\text{SNR})} \\ &= 1 \end{aligned}$$

DoF is a measure of how capacity **scales** with SNR.

Generalized Degrees of Freedom

Normalization (per-user)

Sum-rate

$$\text{GDoF}(\alpha) = \frac{1}{2} \limsup_{\text{SNR} \rightarrow \infty} \frac{\max(R_1 + R_2)}{\frac{1}{2} \log(\text{SNR})}$$

$$\alpha = \frac{\log(\text{INR})}{\log(\text{SNR})}$$

Interference free rate

Interference parameter

- ▶ GDoF captures behavior when SNR, INR are high
- ▶ System is **constrained** by **interference** (not by noise)

GDoF without Feedback

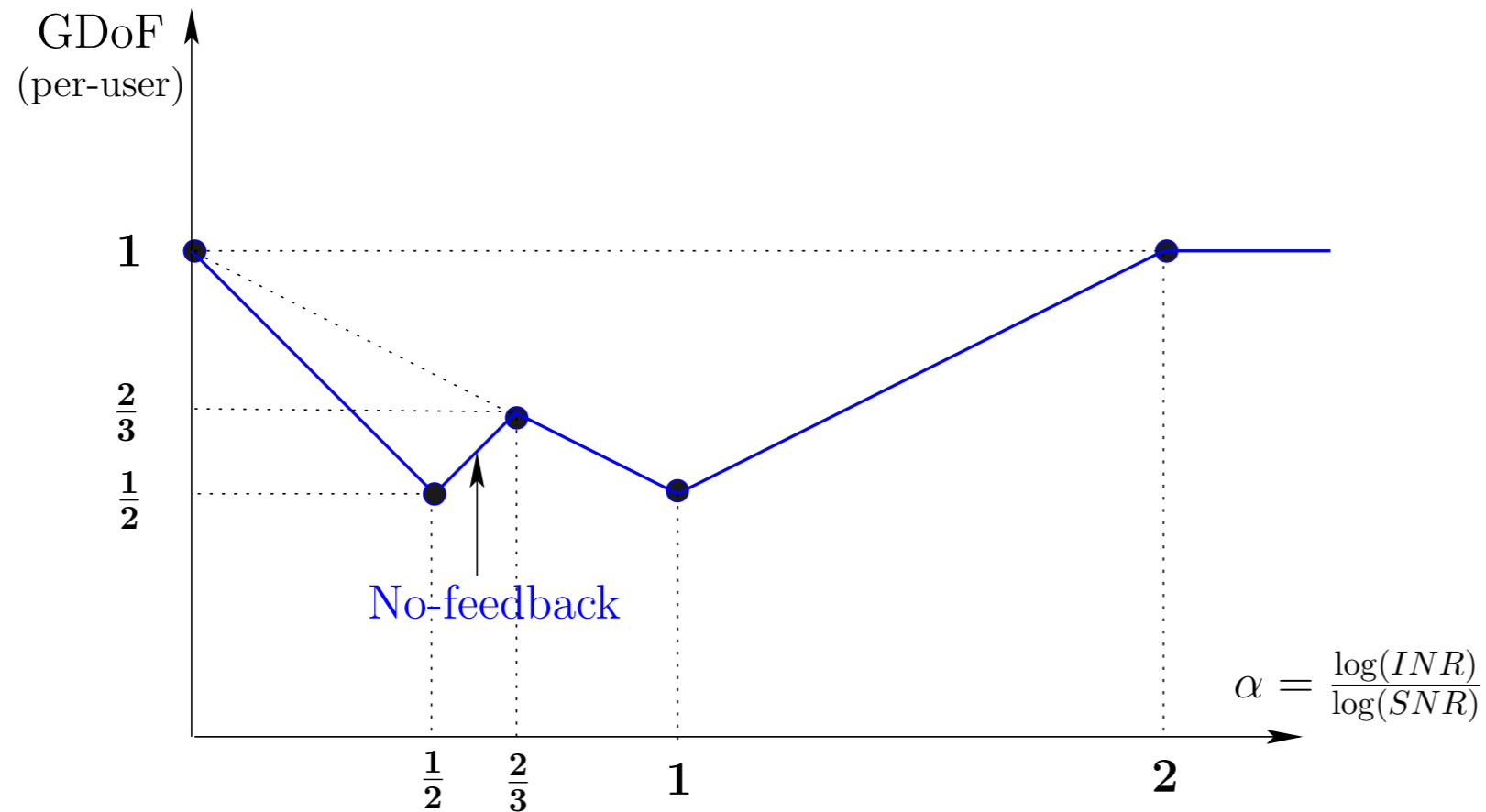

- ▶ GDoF is a **W-curve** [Etkin-Tse-Wang IT'08]
- ▶ **Saturates** beyond 2 [very-high interference]

GDoF with Feedback

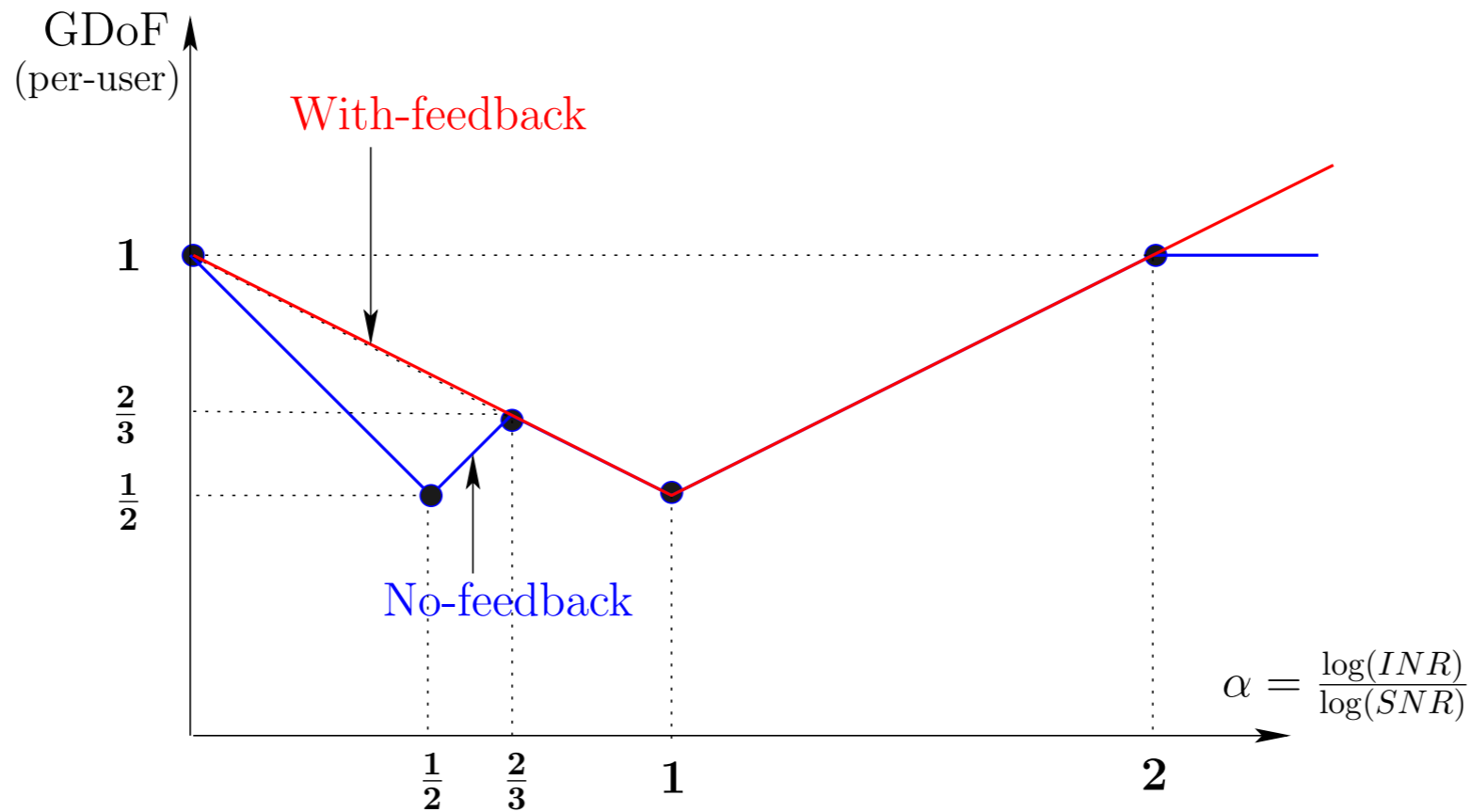

- ▶ GDoF is a **V-curve** [Suh-Tse, IT' 11]
- ▶ **Increasing** beyond 2 [very-high interference].

Why Feedback Helps

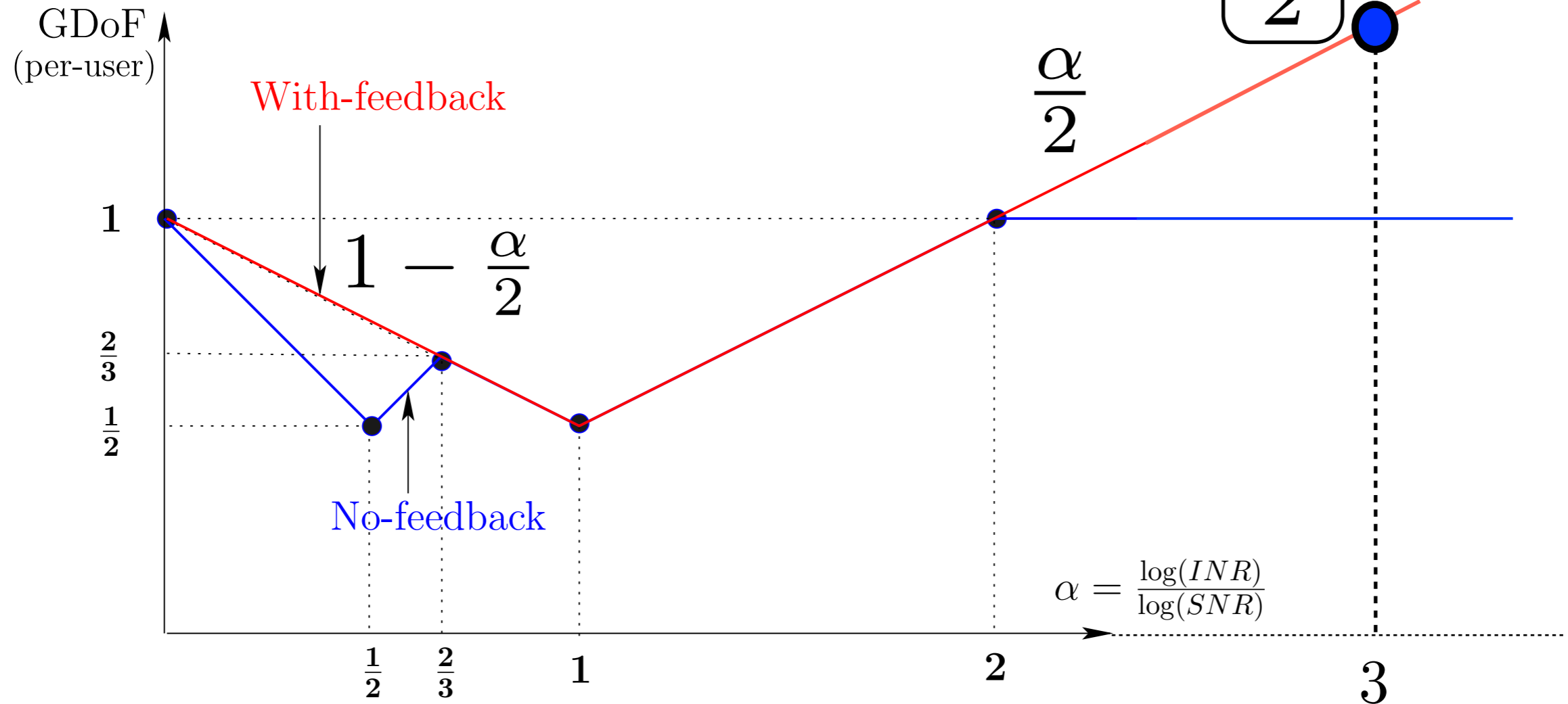

Intuition Via Linear Deterministic Model

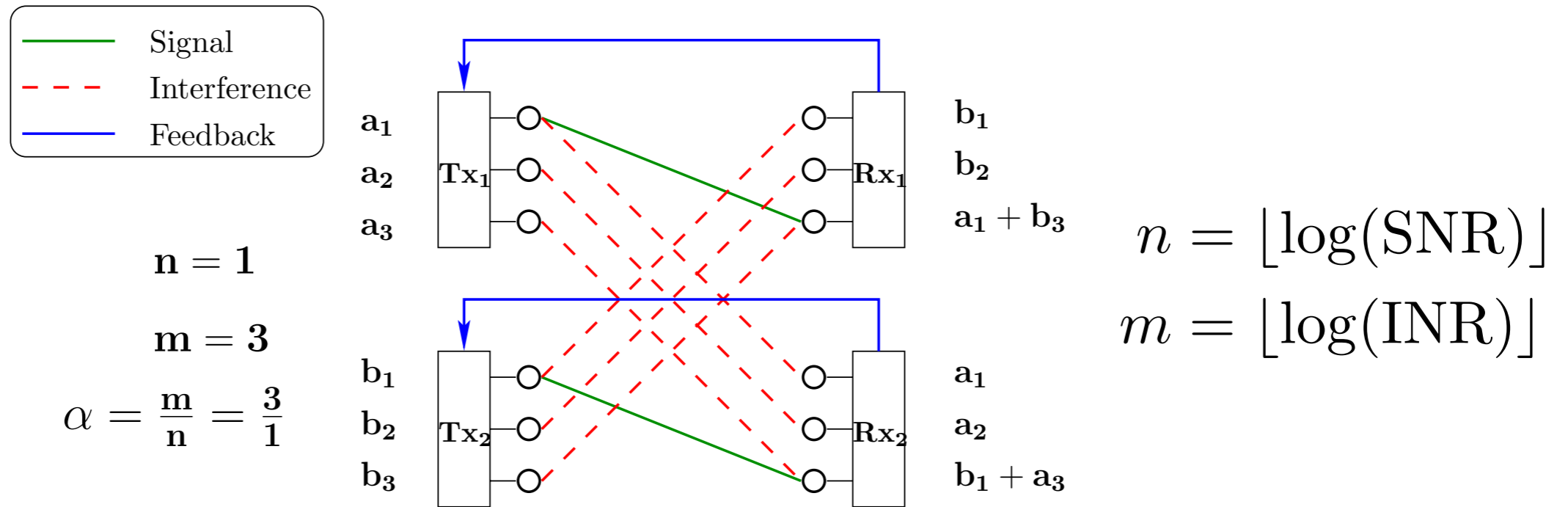

► Linear Deterministic Interference Channel

$$y_1 = \lfloor 2^n x_1 \rfloor \oplus \lfloor 2^m x_2 \rfloor$$

$$y_2 = \lfloor 2^m x_1 \rfloor \oplus \lfloor 2^n x_2 \rfloor$$

► **Approximation** for Gaussian Interference Channel

Achieving $3/2$ (per-user) with Feedback

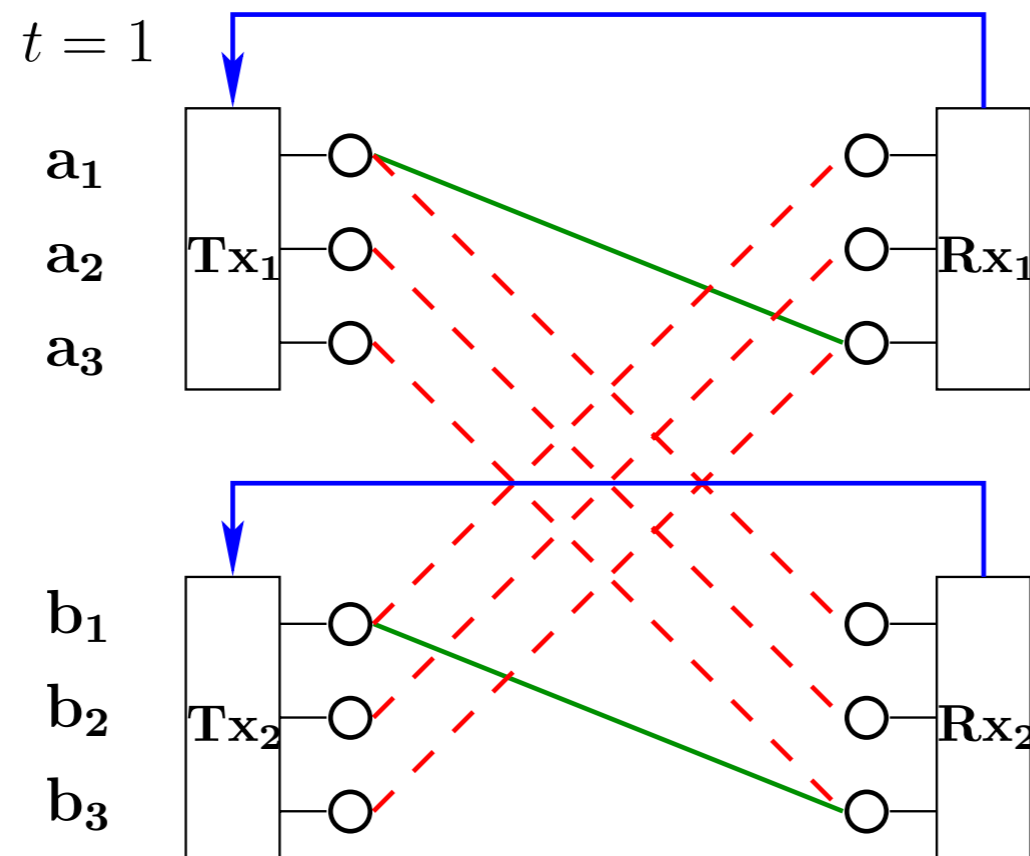

Achieving $3/2$ (per-user) with Feedback

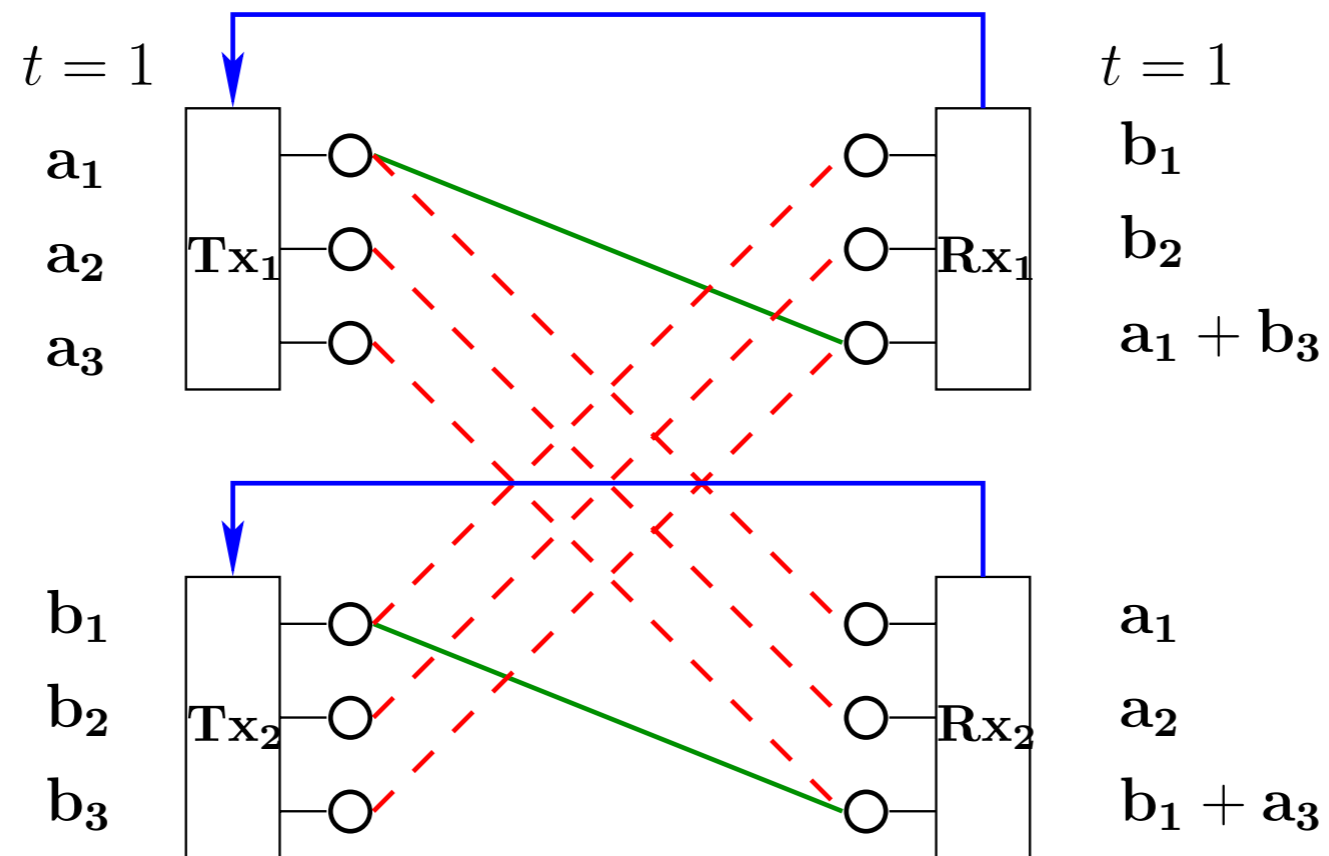

Achieving 3/2 (per-user) with Feedback

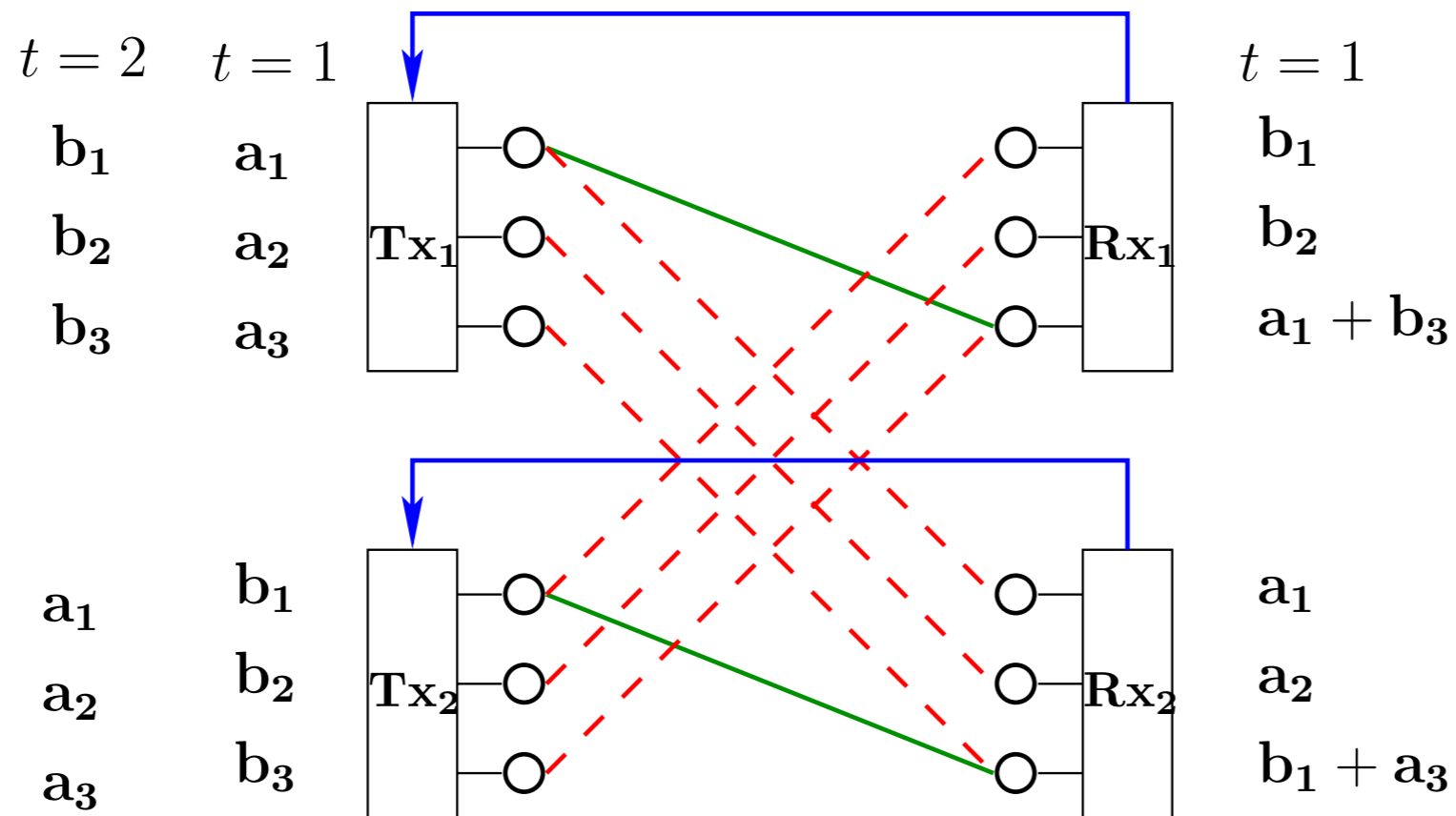

Achieving 3/2 (per-user) with Feedback

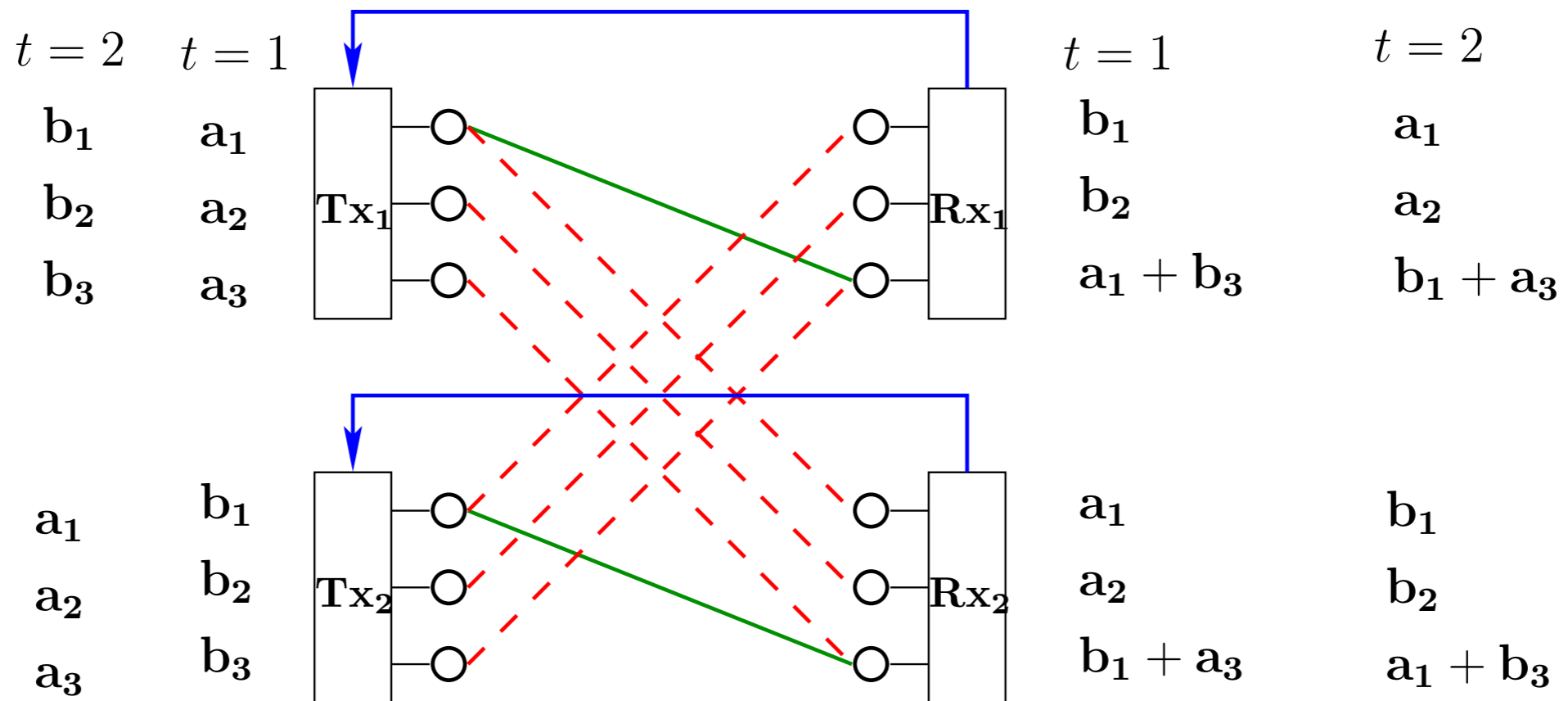

Feedback Provides **Alternative Path** to Rx

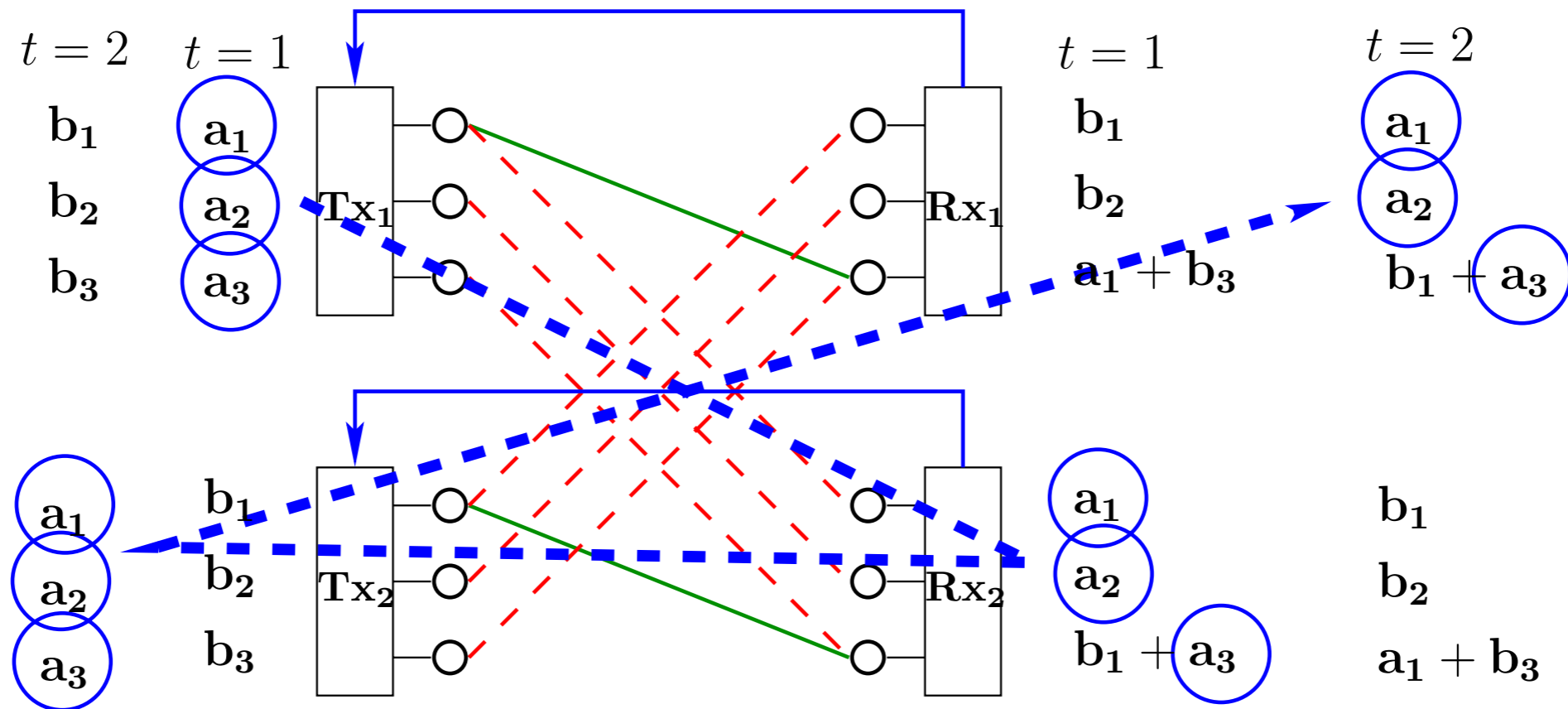

Natural Questions

Q1: Do these results extend to more than two users?

Q2: If yes, how much does feedback help?

Q3: Dependence of feedback gains on network topology?

Natural Questions

Q1: Do these results extend to more than two users?

A1: Yes, to (at least) fully connected and ring networks.

Q2: If yes, how much does feedback help?

A2: Sometimes, feedback provides unbounded gains.

Q3: Dependence of feedback gains on network topology?

A3: In general, feedback gain depends on topology.

Fully Connected K-user Interference Channel

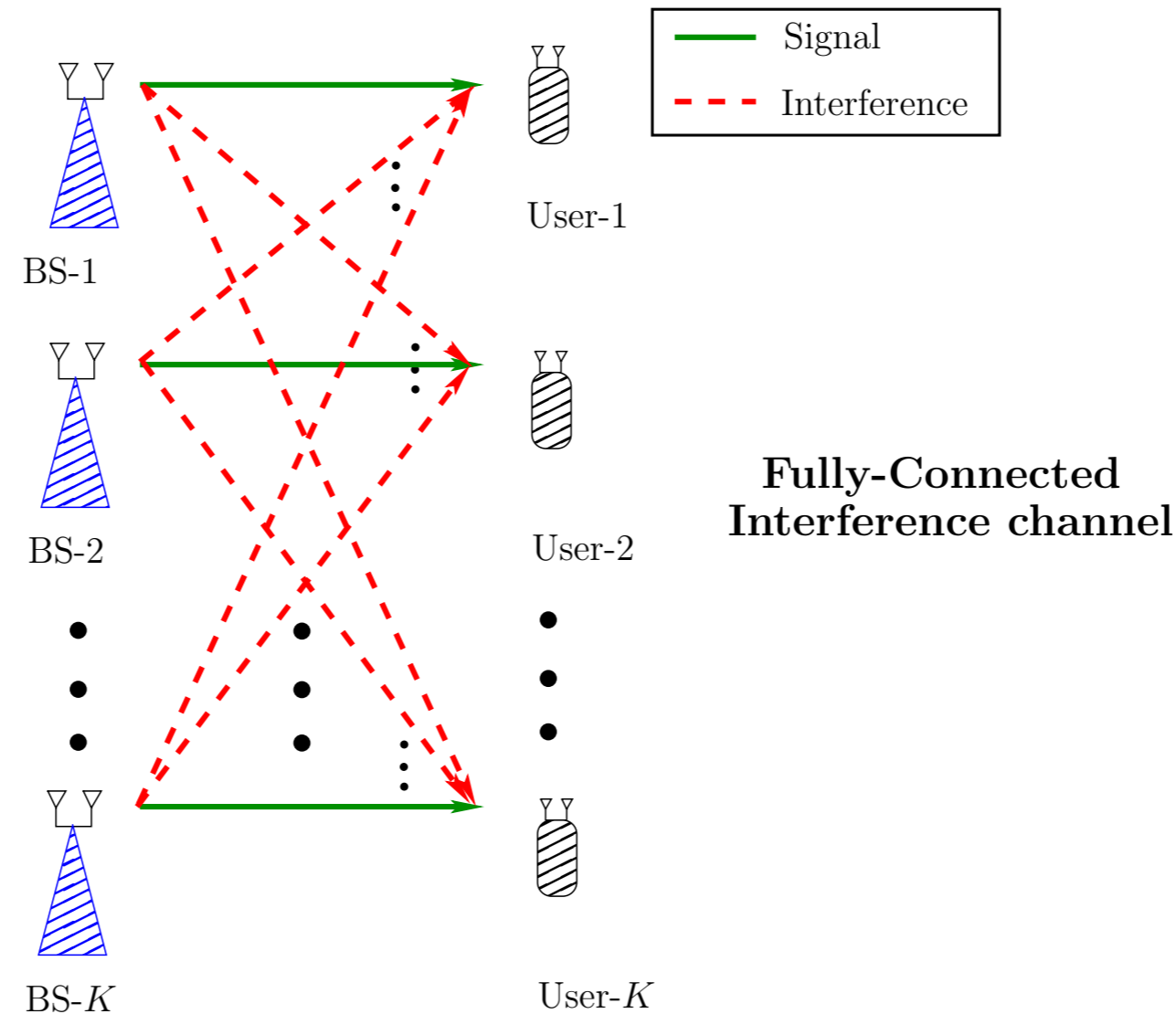

- ▶ Natural generalization of 2-user IC
- ▶ Every base-station interferes with every user

Cyclic K-user Interference Channel

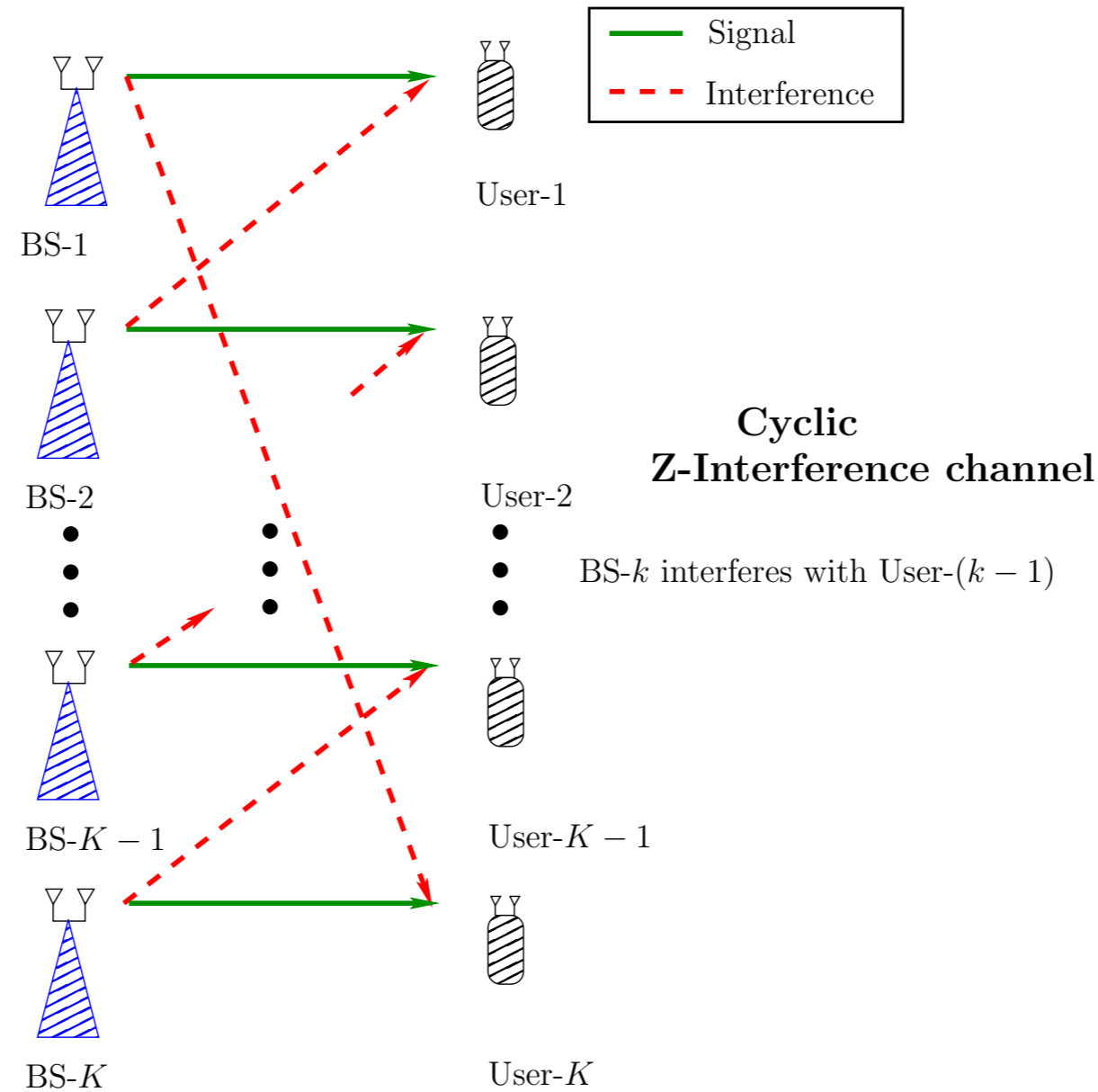

- ▶ Inspired by Wyner model for cellular network
- ▶ BS k interferes with user $(k-1)$

Known Results: GDoF **without** Feedback

Fully Connected IC [Jafar-Viswanath, IT'10]

$$GDoF_{FC}^{No-FB}(\alpha) = \begin{cases} 1 - \alpha, & \alpha \in [0, 1/2) \\ \alpha, & \alpha \in [1/2, 2/3) \\ \alpha/2, & \alpha \in [2/3, 1) \\ 1/K, & \alpha = 1 \\ 1 - \alpha/2, & \alpha \in (1, 2) \\ 1, & \alpha > 2. \end{cases}$$

Cyclic IC [Zhou-Yu, IT'13]

$$GDoF_{Cyclic}^{No-FB}(\alpha) = \begin{cases} 1 - \alpha, & \alpha \in [0, 1/2) \\ \alpha, & \alpha \in [1/2, 2/3) \\ \alpha/2, & \alpha \in [2/3, 1) \\ 1 - \alpha/2, & \alpha \in [1, 2) \\ 1, & \alpha \geq 2. \end{cases}$$

Our Contribution: GDoF with Feedback

Fully Connected IC [Mohajer-Tandon-Poor IT'13]

$$GDoF_{FC}^{FB}(\alpha) = \begin{cases} 1 - \alpha/2, & \alpha \in [0, 1) \\ 1/K, & \alpha = 1 \\ \alpha/2, & \alpha \in (1, \infty). \end{cases}$$

Cyclic IC [Tandon-Mohajer-Poor IT'13]

$$GDoF_{Cyclic}^{FB}(\alpha) = \begin{cases} 1 - \alpha + \frac{\alpha}{K}, & \alpha \in [0, 1/2) \\ \alpha + \frac{2-3\alpha}{K}, & \alpha \in [1/2, 2/3) \\ \alpha/2, & \alpha \in [2/3, 1) \\ 1 - \alpha/2, & \alpha \in [1, 2) \\ 1 + \frac{\alpha-2}{K}, & \alpha \geq 2. \end{cases}$$

GDoF Curves **with** and **without** Feedback

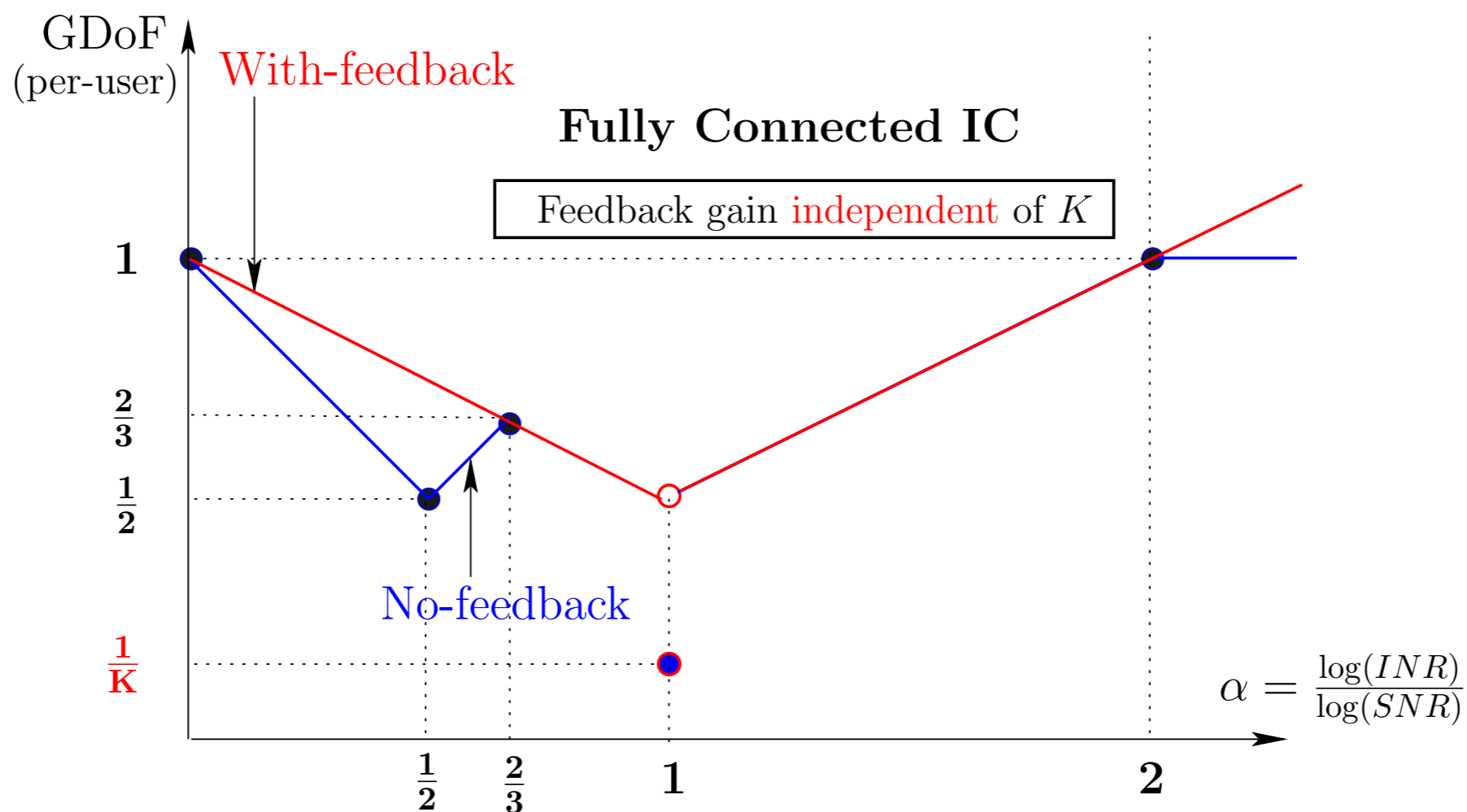

Per-user feedback gain is **independent** of K .

GDoF Curves **with** and **without** Feedback

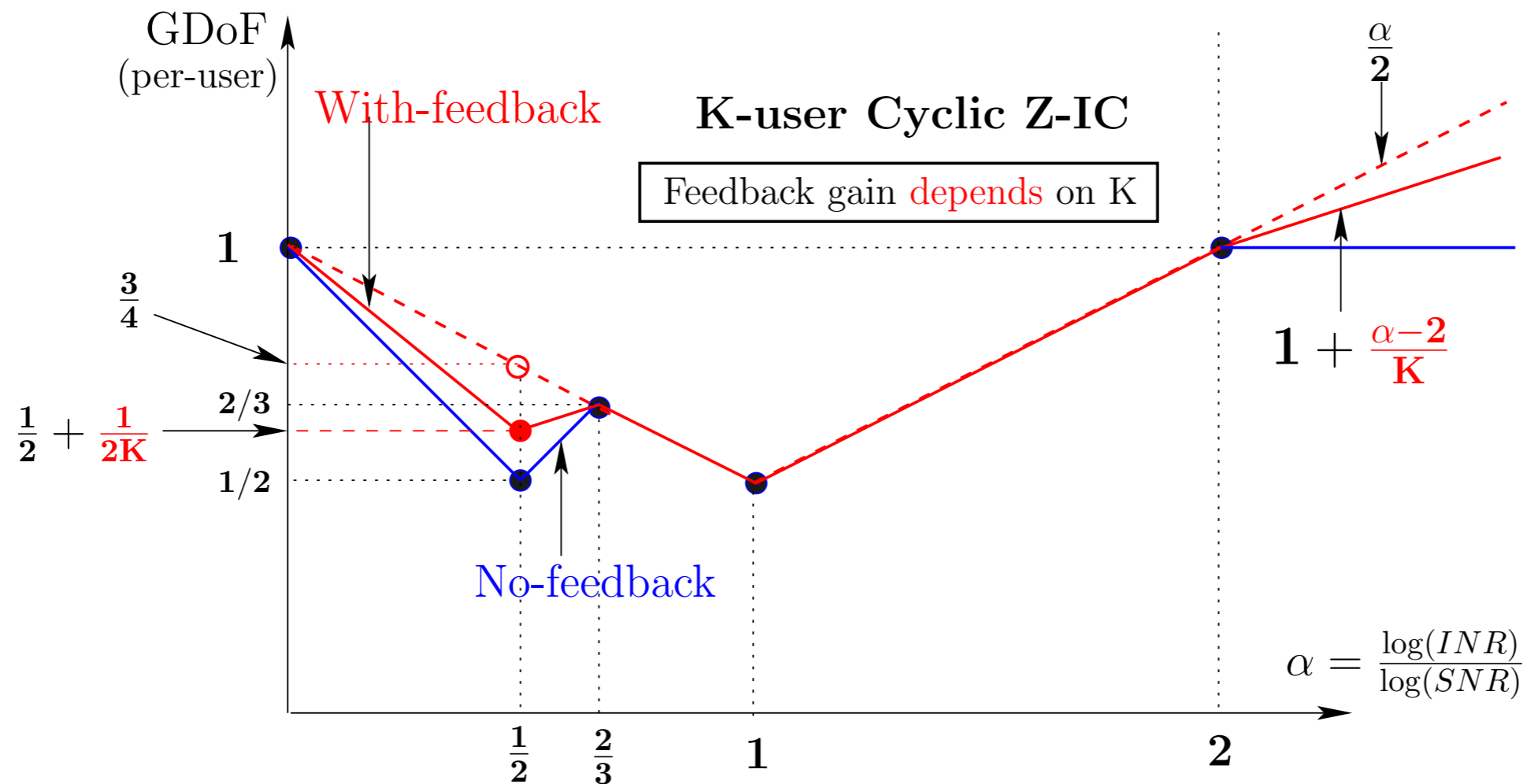

Per-user feedback gain **depends** on K.
 As K increases, **V-curve** \dashrightarrow **W-Curve**

3-user Fully Connected Interference Channel

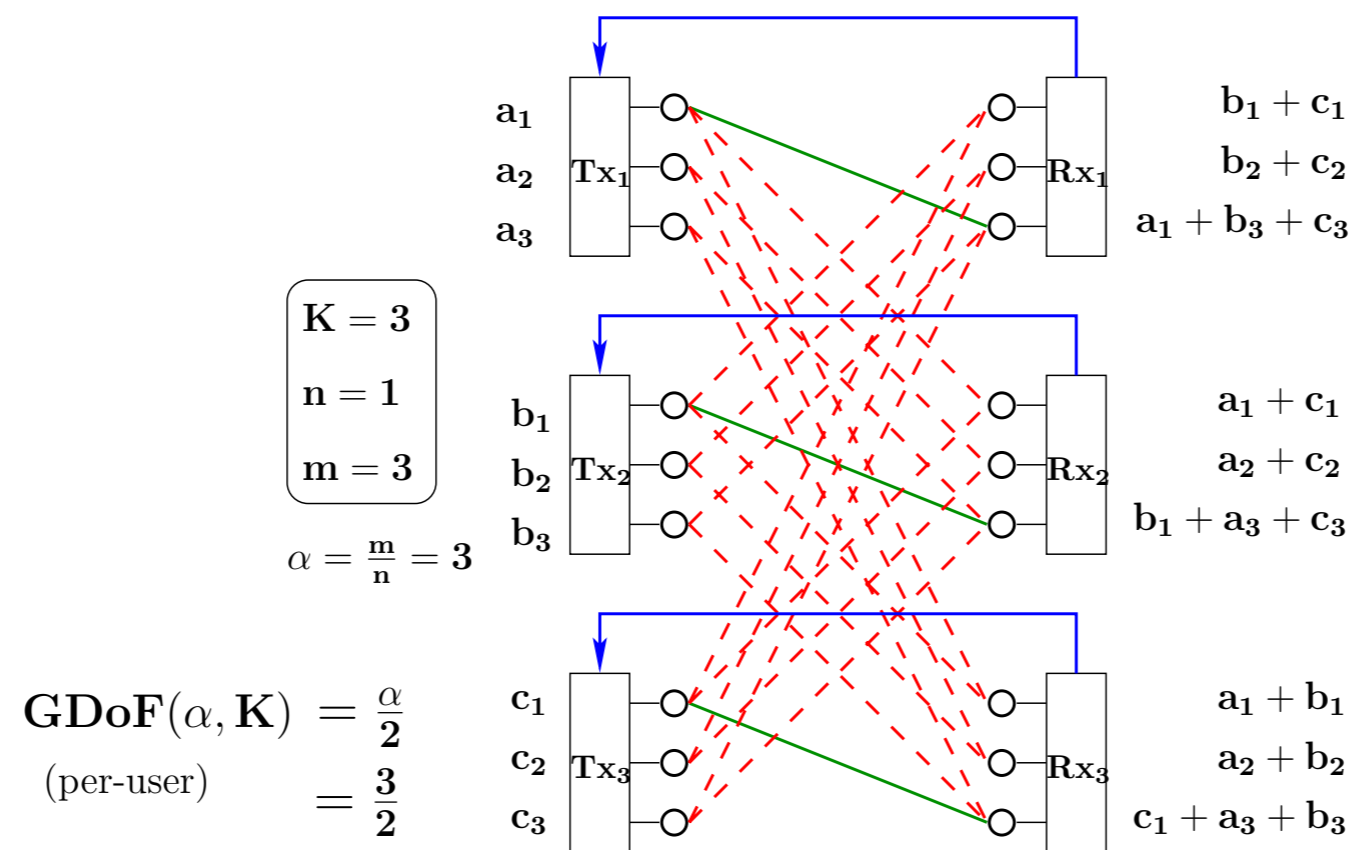

Can **feedback** help in transmission of 3 bits per user in 2 channel uses ?

Coding Scheme: Main Idea

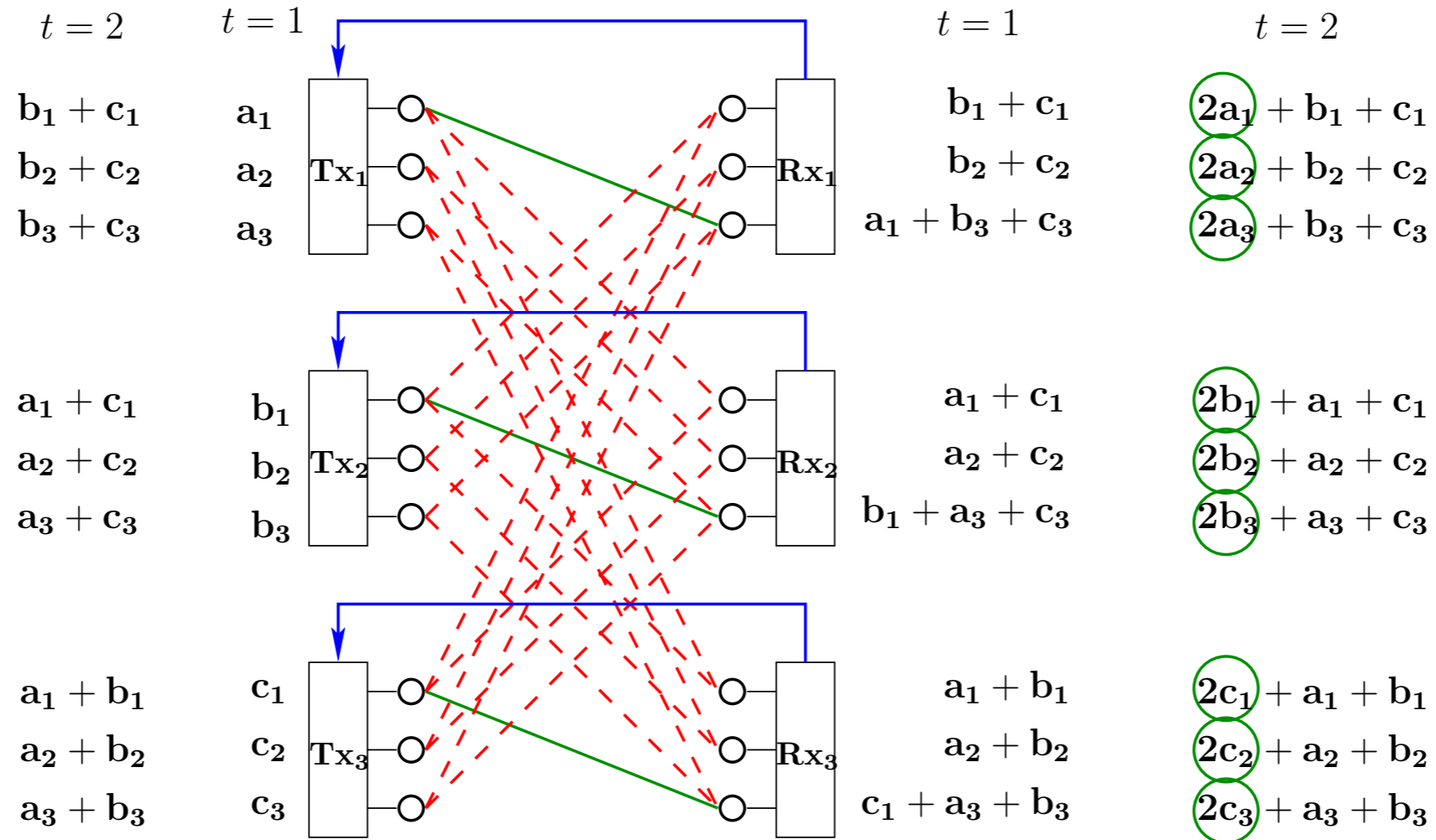

Transmitters decode **net**-interference via Feedback
 Interference at $t=2$ should be the **same** as the clean signal at $t=1$.

Translation to the Gaussian Model

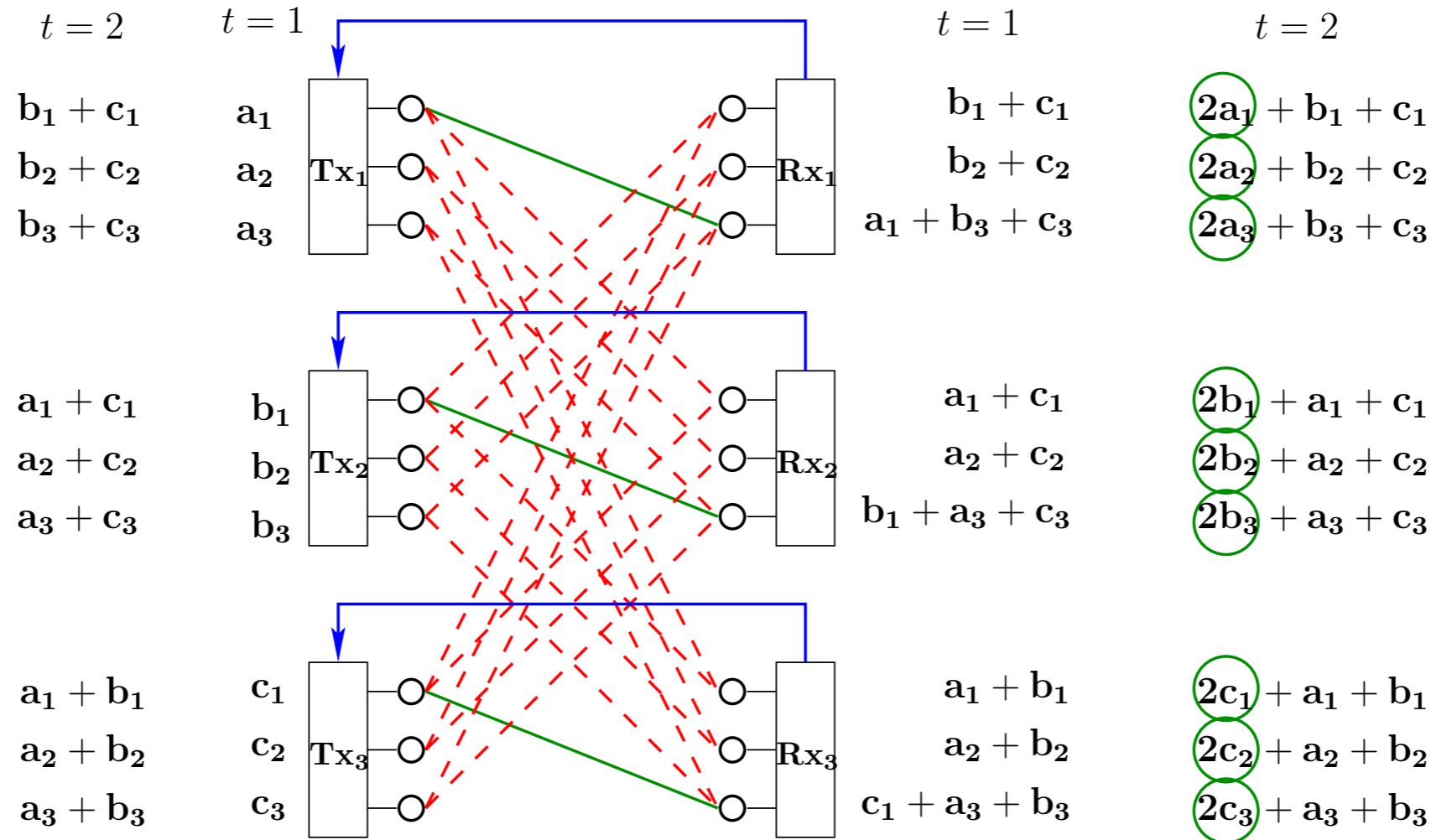

Sum of two-(or more)-codewords should be a codeword.

Nested Lattice Codes for interference alignment.

Decoding of lattice codeword(s) \longrightarrow cancel off to decode **signal**.

Summary: Static Interference Channels

- ▶ Feedback can help exploit alternative paths to the receivers
- ▶ Significant capacity gains possible
- ▶ Connections of feedback gains to network topology
- ▶ More interference does **not** necessarily imply **less** feedback gain

Outline

- Background
 - ✘ Point-to-point channels
 - ✘ Multi-terminal channels
- Static Interference Channels
 - ✘ Why feedback helps
 - ✘ Feedback gain for many-user interference channels
- **Fading MISO Broadcast Channels**
 - ✘ The effects of channel state feedback
 - ✘ Spatio-temporal variation in channel state feedback

Interference Mitigation via MIMO

- ▶ Downlink multi-user MIMO (spatial multiplexing)
- ▶ Inter-cell interference mitigation
- ▶ Coordinated multi-point (CoMP in LTE)
- ▶ Key enabler in all approaches:

▶ **Accurate** & **timely** channel knowledge at transmitter(s)

Focus: K-user Downlink MISO

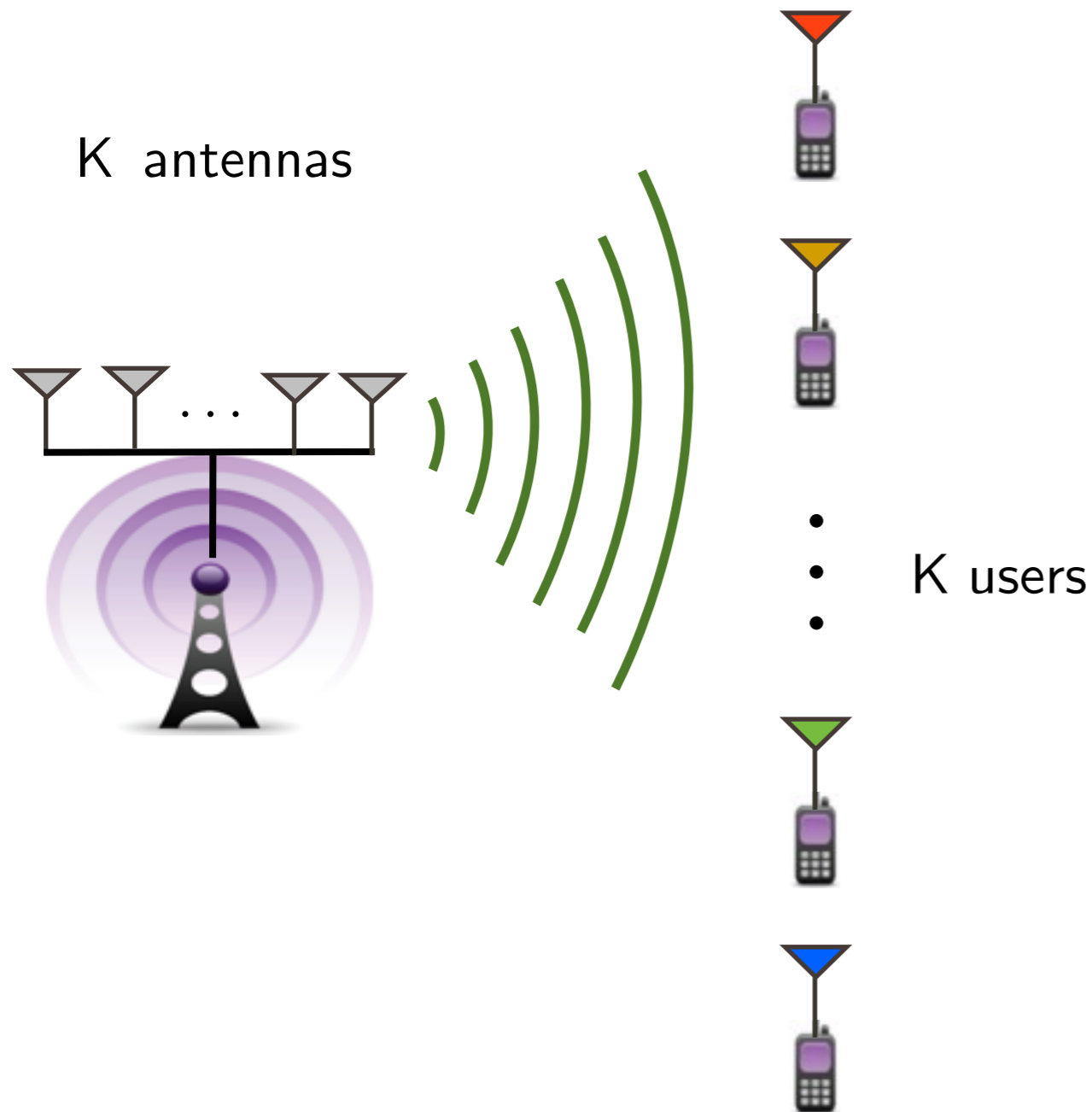

Perfect Channel Knowledge

Degrees of Freedom = K

No Channel Knowledge

Degrees of Freedom = 1

Focus: K-user Downlink MISO

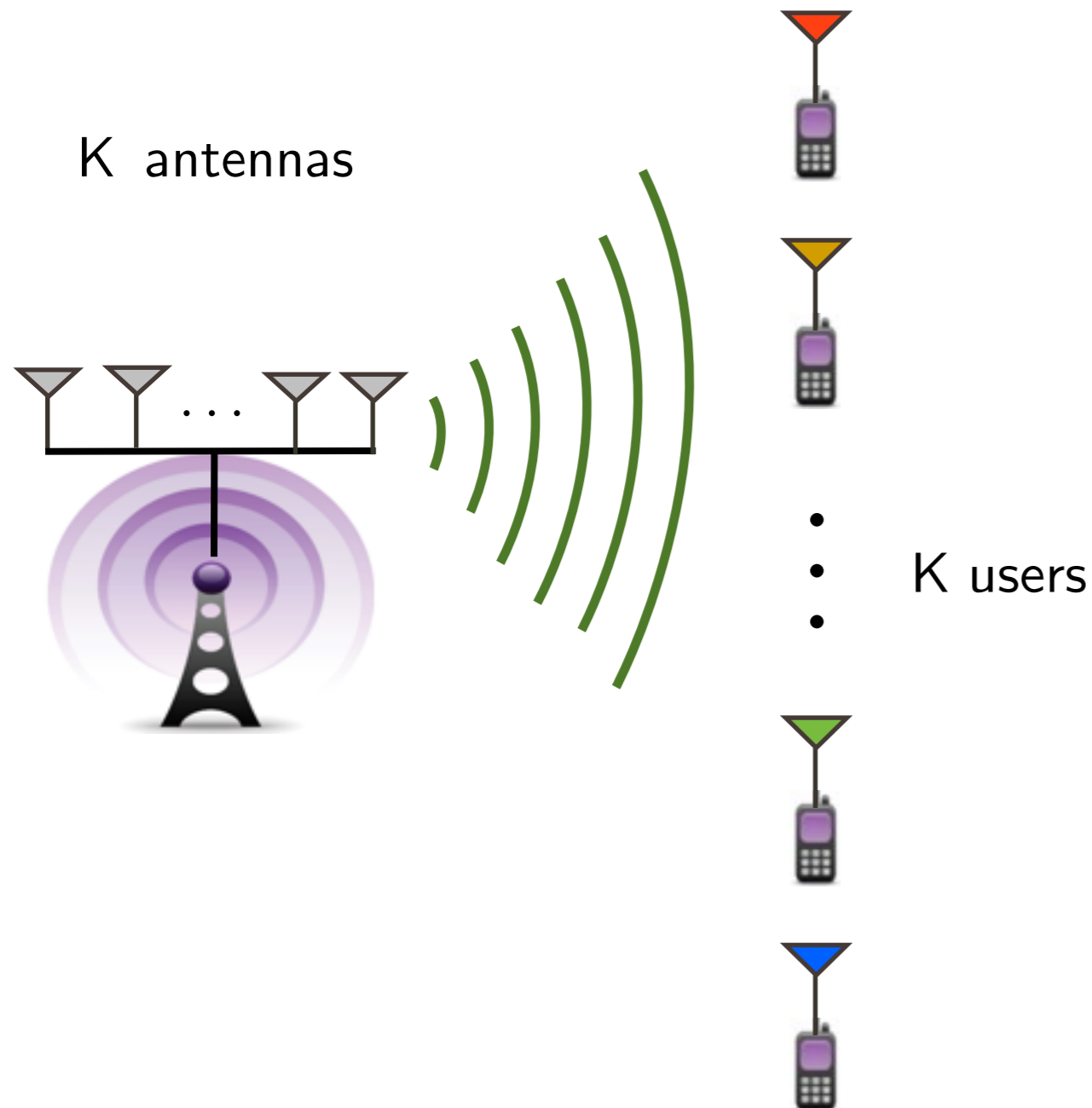

Perfect Channel Knowledge

Degrees of Freedom = K

Delayed Channel Knowledge

?

No Channel Knowledge

Degrees of Freedom = 1

Basic Model: Two-user Downlink MISO

Perfect Channel Knowledge– DoF = 2

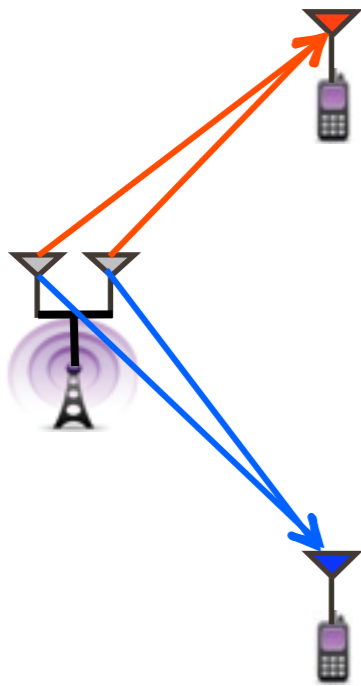

Delayed Channel Knowledge

?

No Channel Knowledge– DoF = 1

Basic Model: Two-user Downlink MISO

Perfect Channel Knowledge– DoF = 2

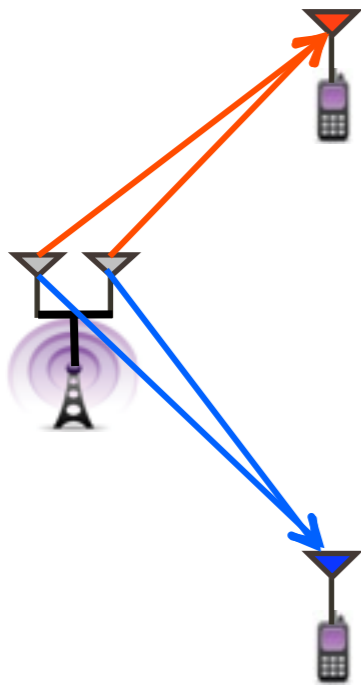

Delayed Channel Knowledge– DoF = $4/3$

[Maddah-Ali, Tse IT'12]

No Channel Knowledge– DoF = 1

Usefulness of Delayed Channel Knowledge

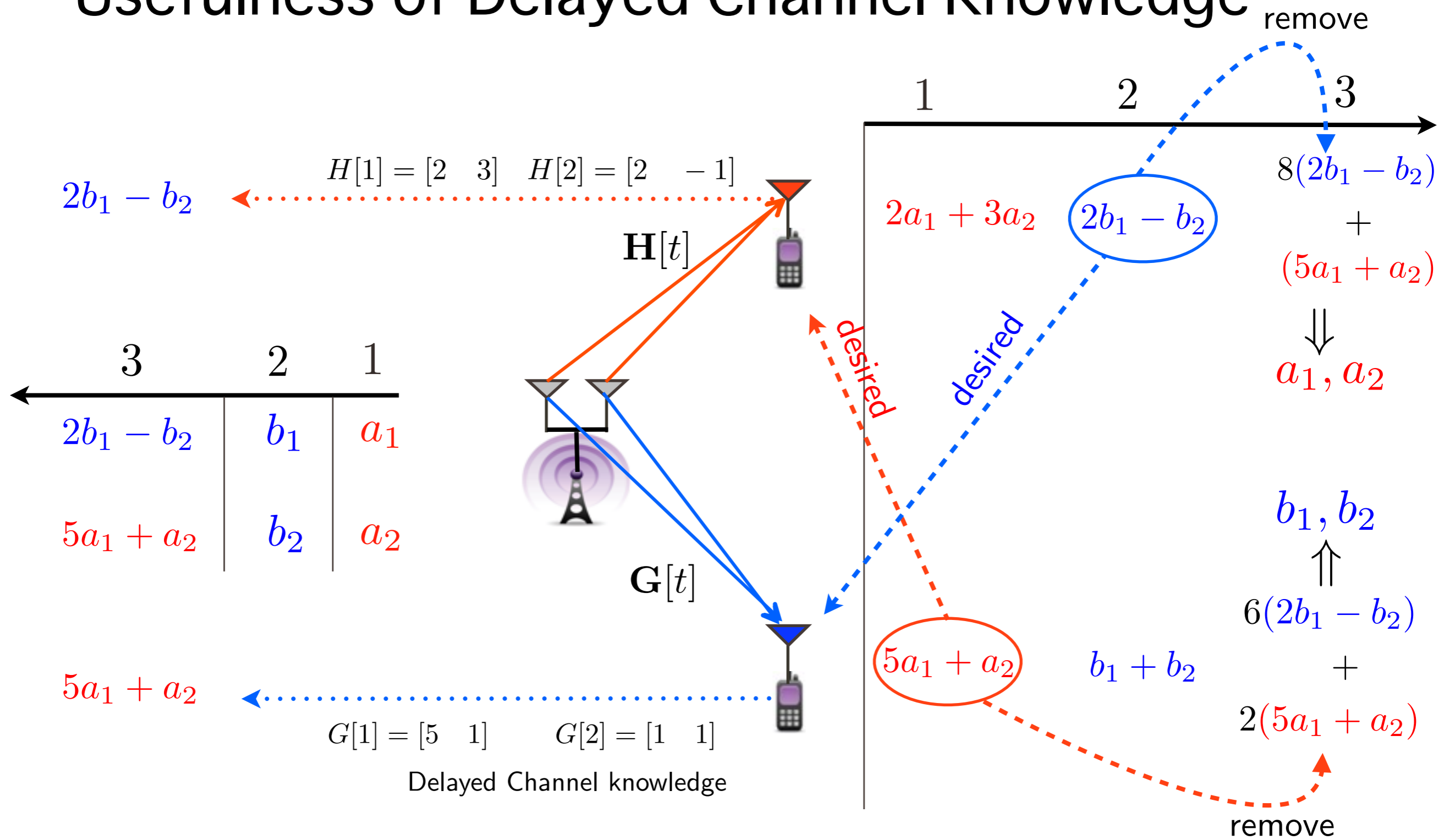

Degrees-of-Freedom = $\frac{4}{3}$ 33% gain! [Maddah-Ali, Tse IT'12]

K-user Downlink MISO

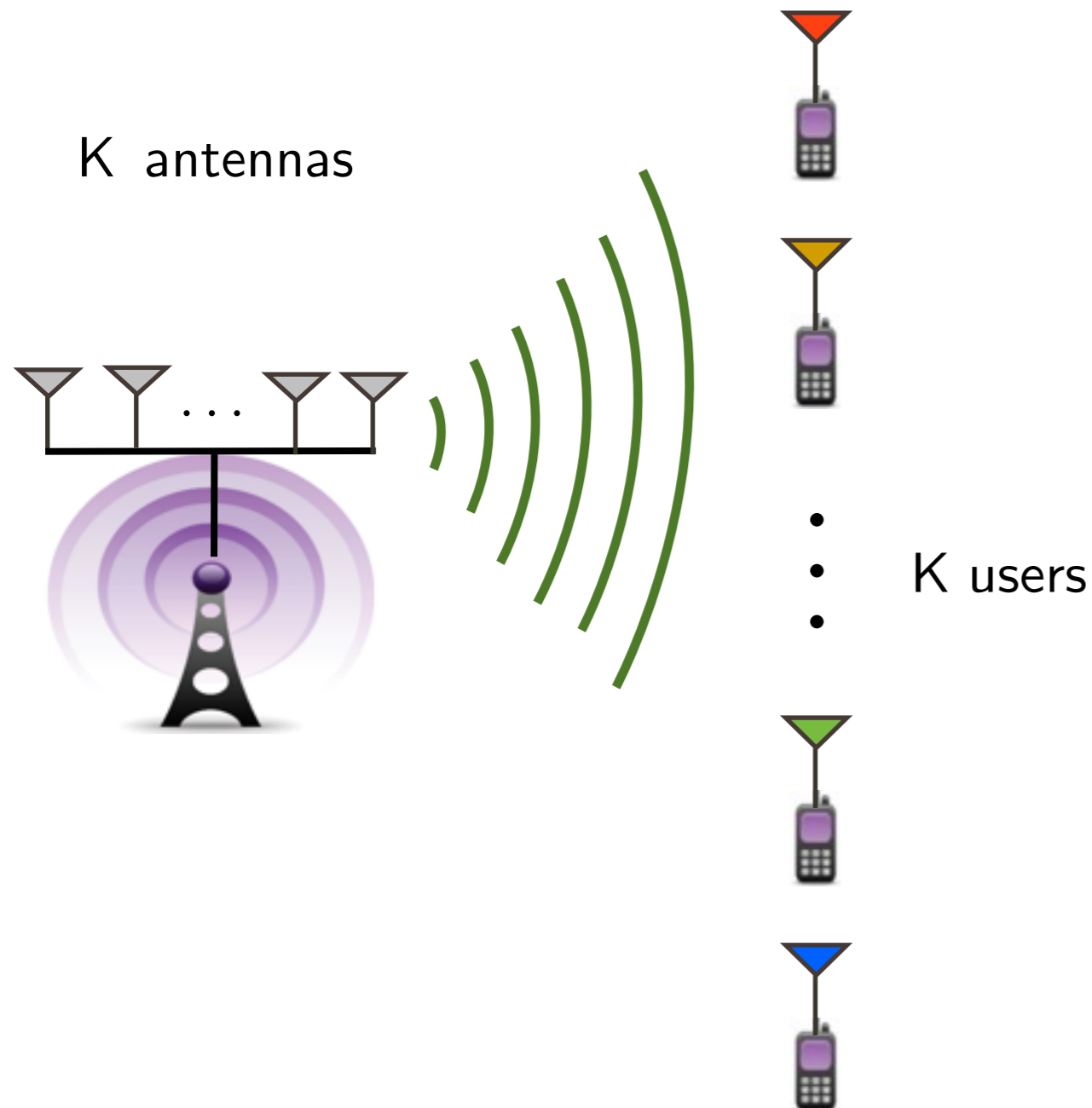

Perfect Channel Knowledge

Degrees of Freedom = K

[Maddah-Ali, Tse IT'12]

Delayed Channel Knowledge

Degrees of Freedom = $\frac{K}{1 + \frac{1}{2} + \dots + \frac{1}{K}}$
 $\approx \frac{K}{\log(K)}$

No Channel Knowledge

Degrees of Freedom = 1

Returning to the Two-user Downlink MISO

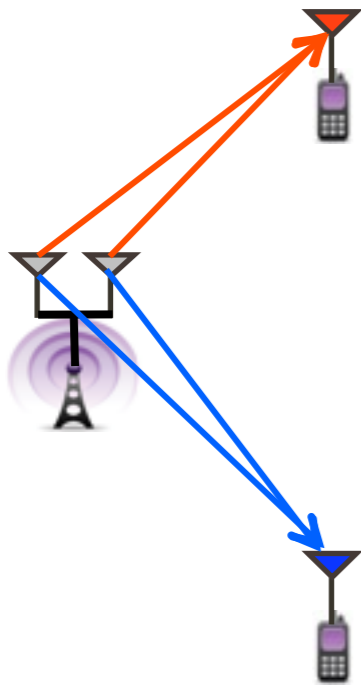

Perfect Channel Knowledge– DoF = 2
(from both users)

Delayed Channel Knowledge– DoF = $4/3$
(from both users)

No Channel Knowledge– DoF = 1

In practice, feedback **quality** and **delay** may **vary** across users.

Heterogenous Channel Knowledge

[Tandon, Maddah-Ali, Tulino, Poor, Shamai - ISWCS'12]

Feedback quality & delay can **vary** across users.

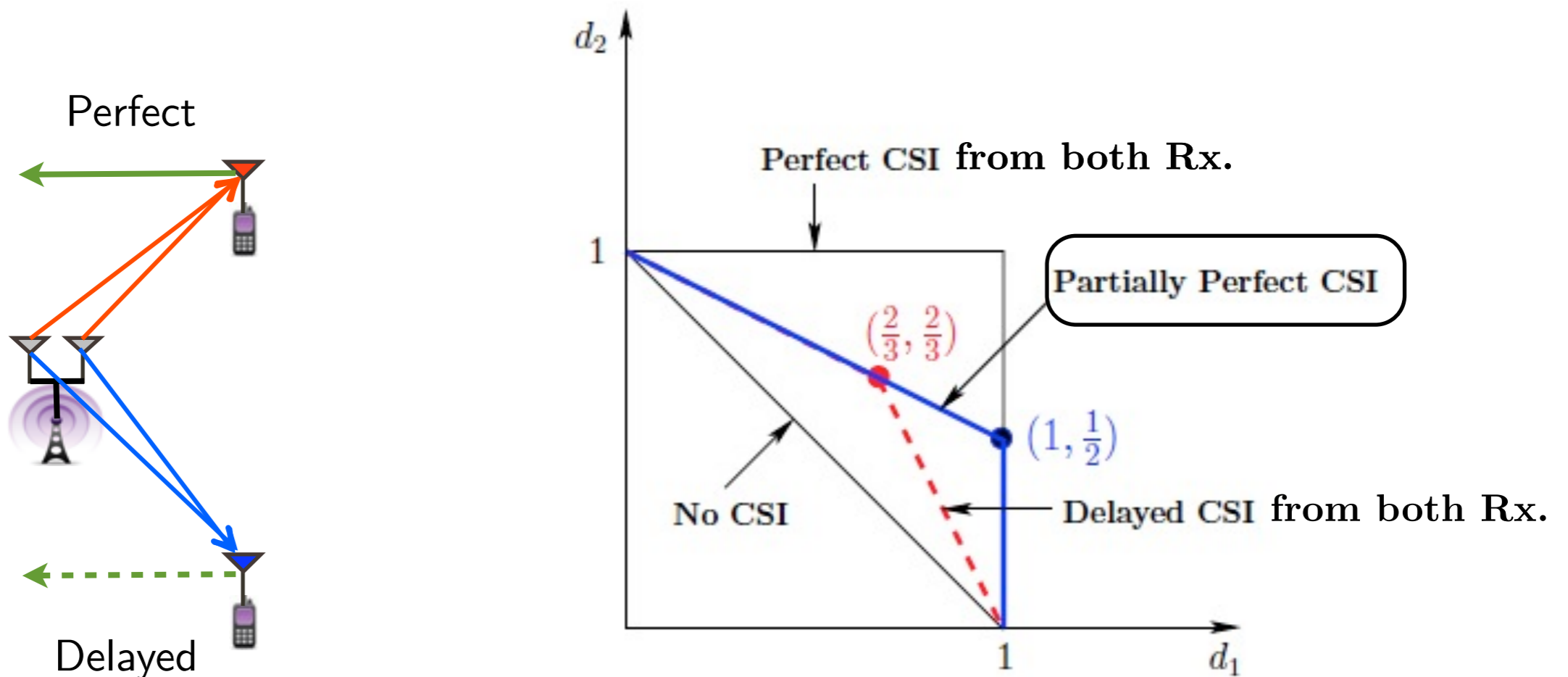

Maximum sum-DoF is at $(1, 1/2)$ with partially perfect CSI.

Achieving Maximum Sum-DoF of 3/2

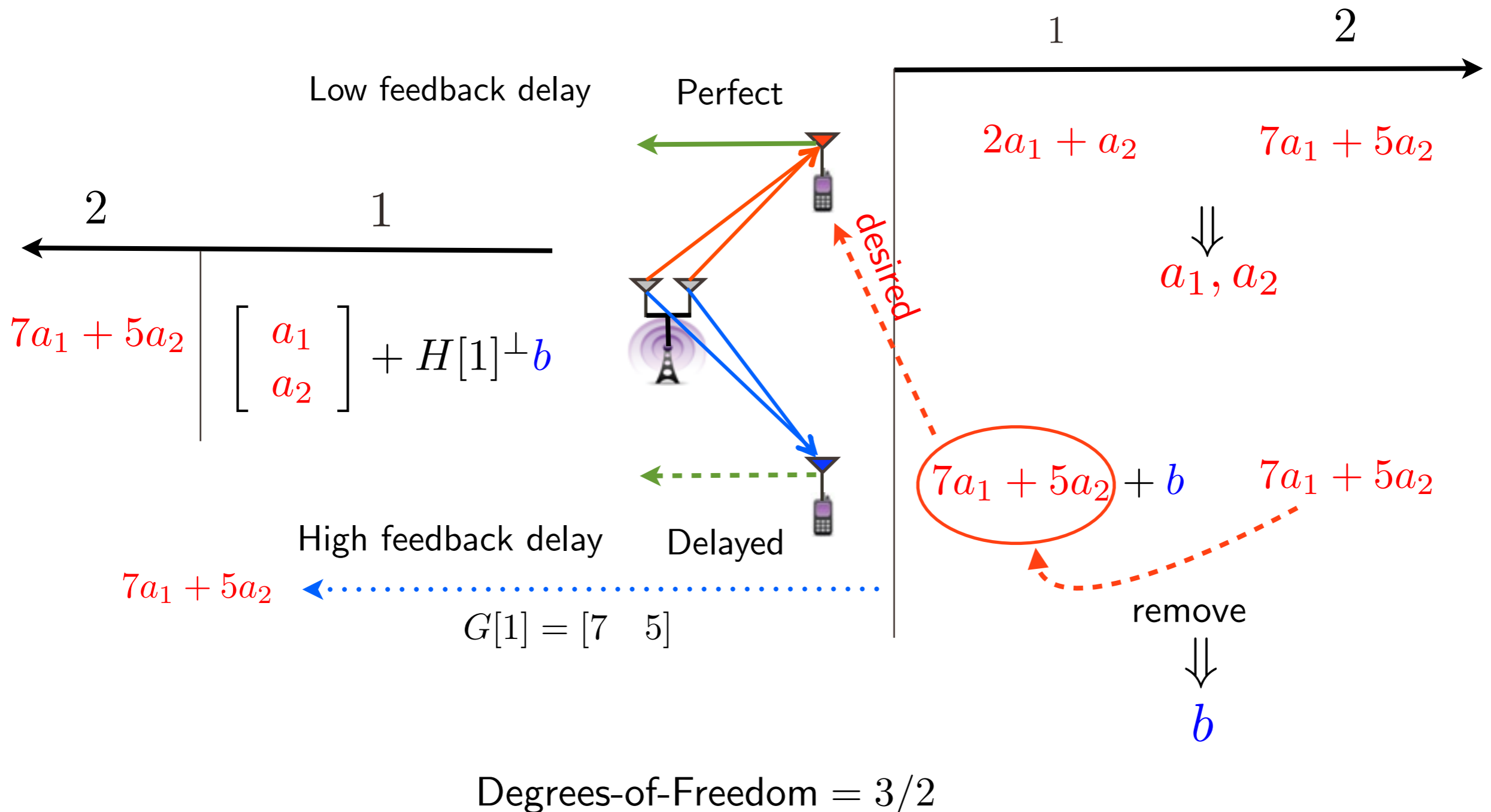

Heterogeneous Channel Knowledge: General Result

[Tandon, Maddah-Ali, Tulino, Poor, Shamai - ISWCS'12]

DoF Region of (M, N_1, N_2) MIMO BC with Partial CSI

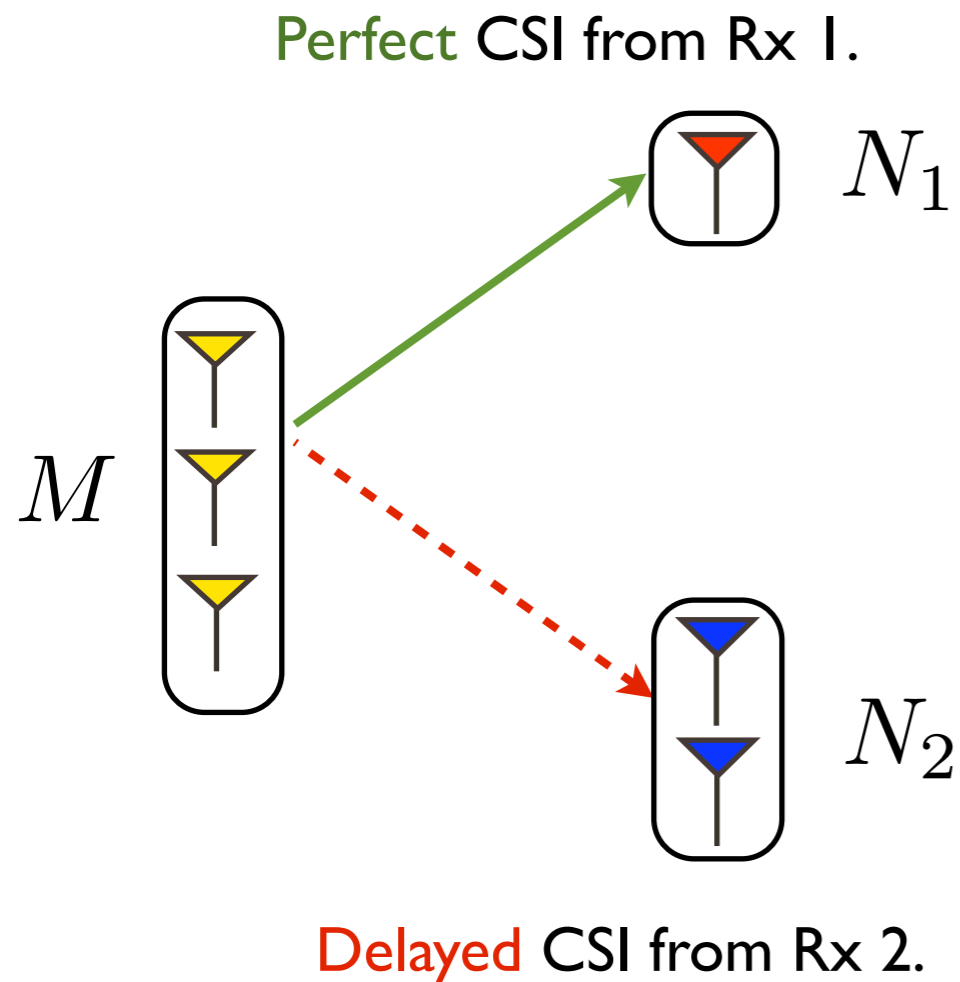

$$d_1 \leq \min(M, N_1)$$
$$\frac{d_1}{\min(M, N_1 + N_2)} + \frac{d_2}{\min(M, N_2)} \leq 1.$$

Spatio-temporal Variation: Alternating CSIT

Feedback quality/delay can vary **across users** and **over time**:

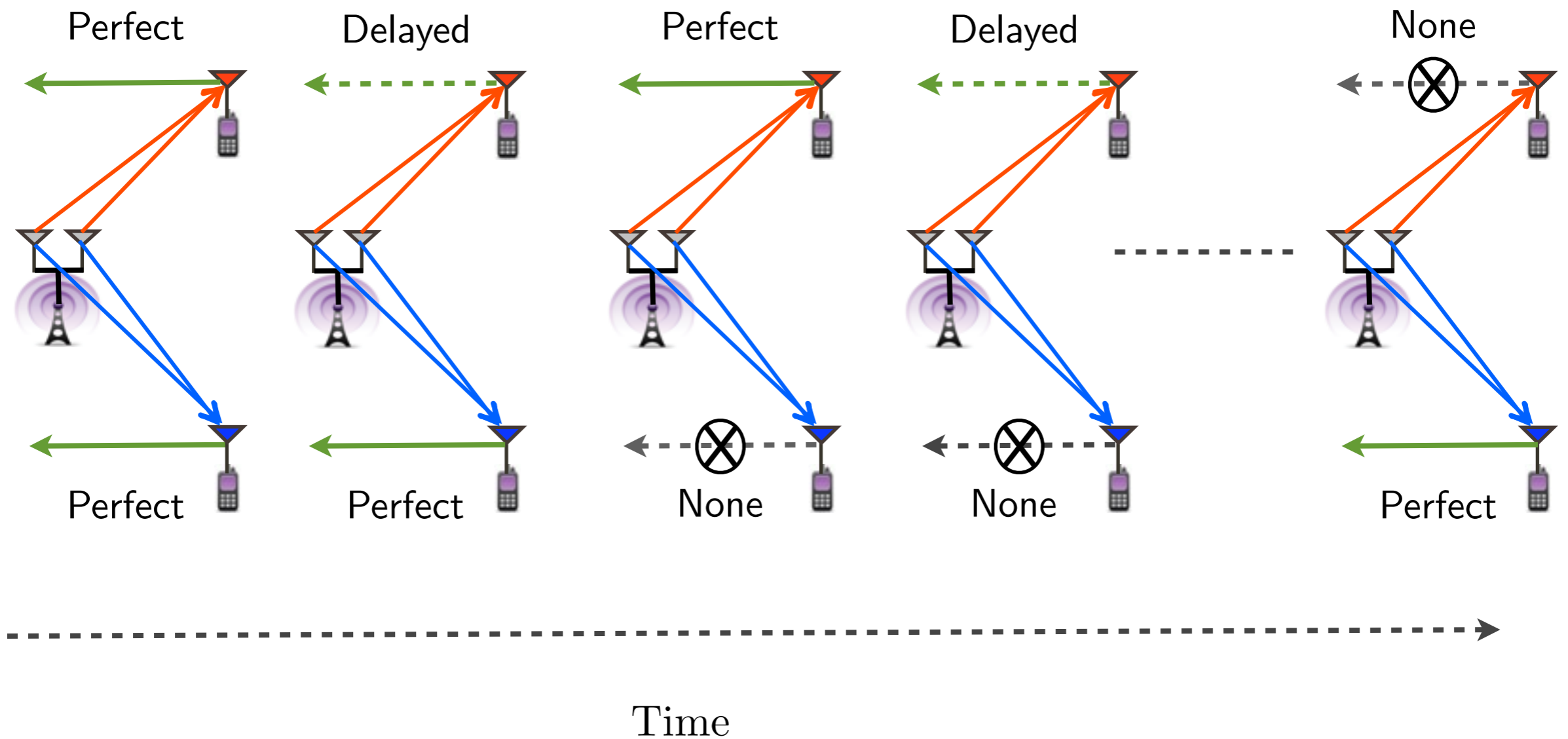

Alternating CSIT

- ▶ **Motivation:**
 - ▶ Time-varying nature of wireless channels
 - ▶ Feedback frequency can vary across users and in time
 - ▶ CSIT acquisition can be deliberately varied (as a design parameter)
- ▶ **Challenges & Benefits:**
 - ▶ Some non-alternating problems are open (optimal DoF not known)
 - ▶ Can be solved under the lens of alternating CSIT
 - ▶ Alternation can provide significant gains

An Example: P-D and D-P

Optimal DoF = $\frac{3}{2}$

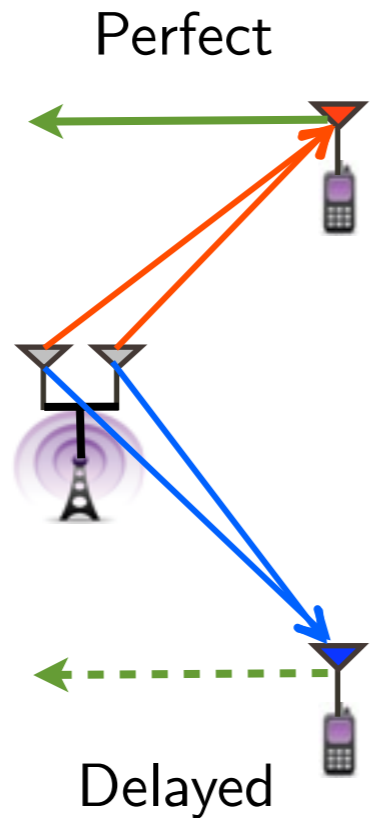

$\frac{2}{3}$ rd fraction of time.

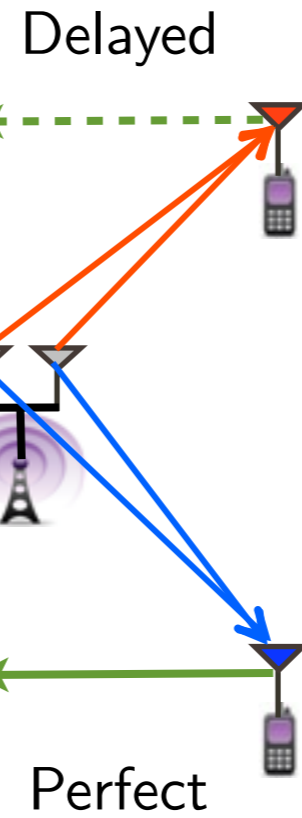

$\frac{1}{3}$ rd fraction of time.

Optimal DoF = $\frac{3}{2}$

We ask: what is the optimal DoF ?

Clearly optimal DoF $\geq \frac{2}{3} \times \frac{3}{2} + \frac{1}{3} \times \frac{3}{2} = \frac{3}{2}$

Optimal DoF = $\frac{5}{3}$ 44% gain

Key Idea: Code Across Multiple CSIT States

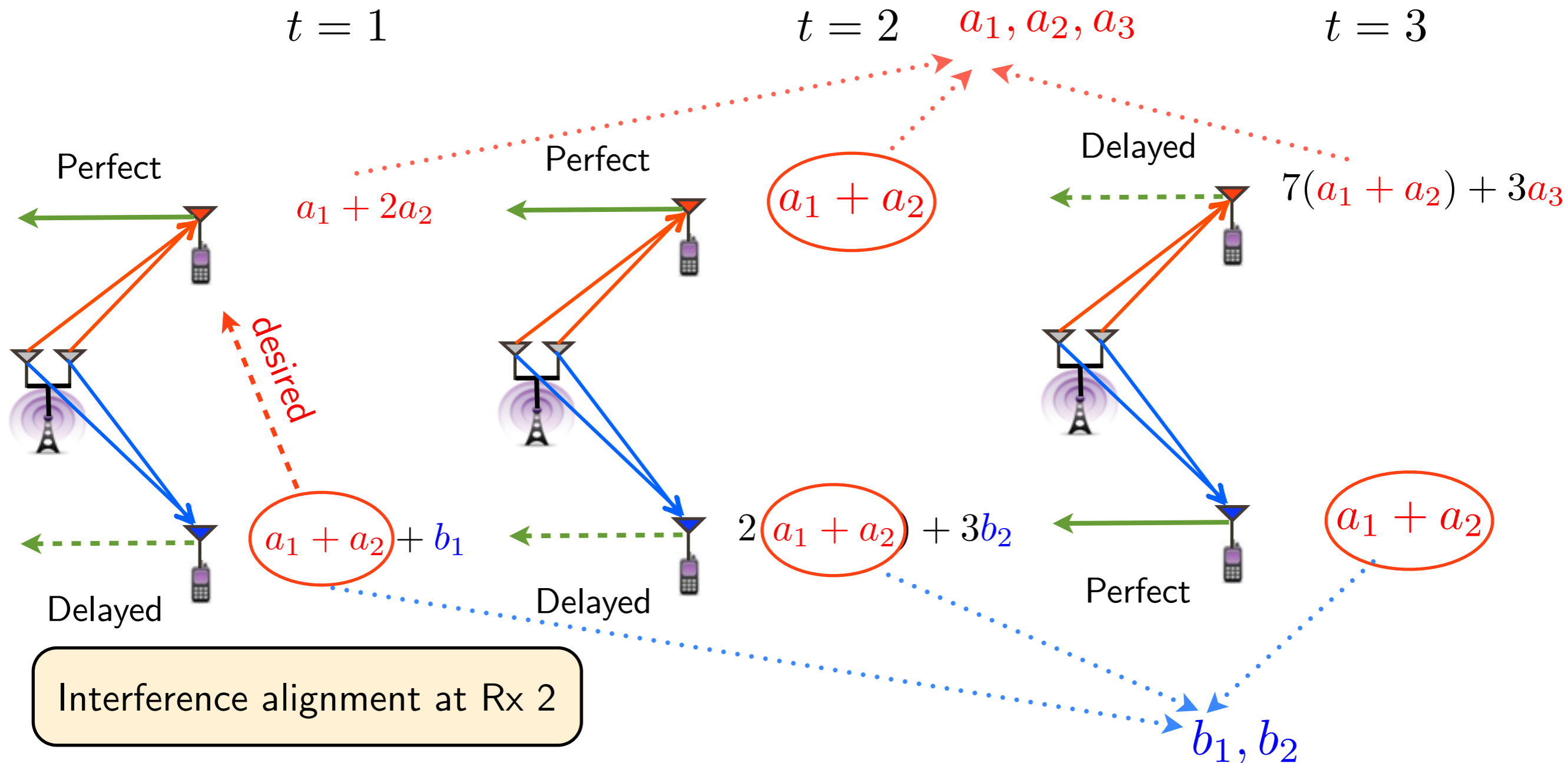

Interference alignment at Rx 2

Degrees of Freedom = $\frac{5}{3}$ 44% gain beyond $3/2$

General Result: Alternating CSIT

- ▶ 9 States: PP, PD, DP, PN, NP, DN, ND, DD, NN

Fraction of occurrence $\lambda_{I_1 I_2}$; $I_1, I_2 \in \{P, D, N\}$

$$\sum_{I_1, I_2} \lambda_{I_1 I_2} = 1 \quad \lambda_{I_1 I_2} = \lambda_{I_2 I_1}$$

$$d_1 \leq 1$$

$$d_2 \leq 1$$

$$d_1 + 2d_2 \leq 2 + \lambda_P$$

$$2d_1 + d_2 \leq 2 + \lambda_P$$

$$d_1 + d_2 \leq 1 + \lambda_P + \lambda_D$$

$$\lambda_P \triangleq \lambda_{PP} + \lambda_{PD} + \lambda_{PN}$$

$$\lambda_D \triangleq \lambda_{DD} + \lambda_{PD} + \lambda_{DN}.$$

[On the Synergistic Benefits of Alternating CSIT for the MISO BC](#)

Tandon-Jafar-Shamai-Poor, IT (to appear)

Tradeoff: Delayed vs Perfect Knowledge

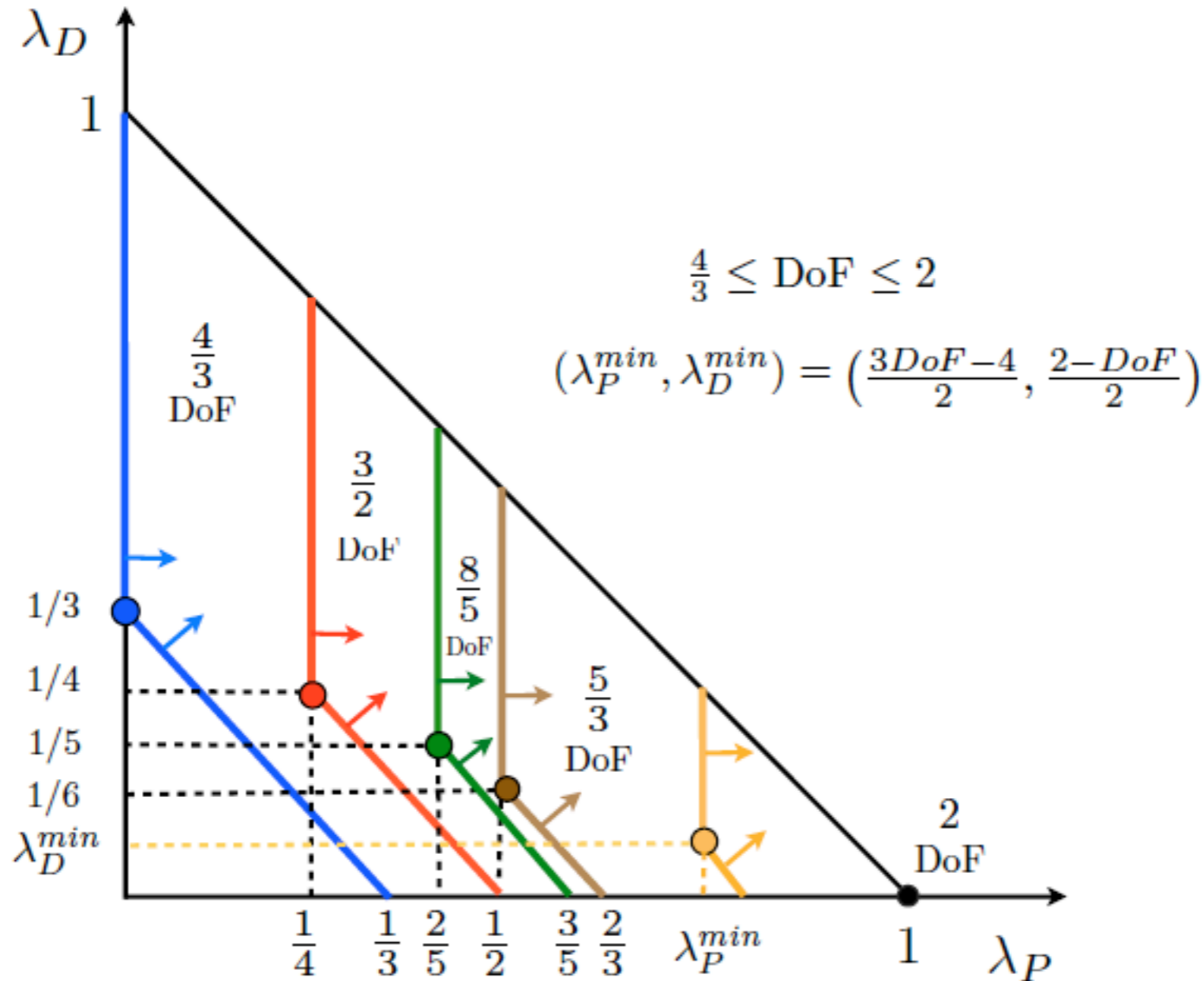

[On the Synergistic Benefits of Alternating CSIT for the MISO BC](#)
Tandon-Jafar-Shamai-Poor, IT (to appear)

Extension: K-user Downlink MISO

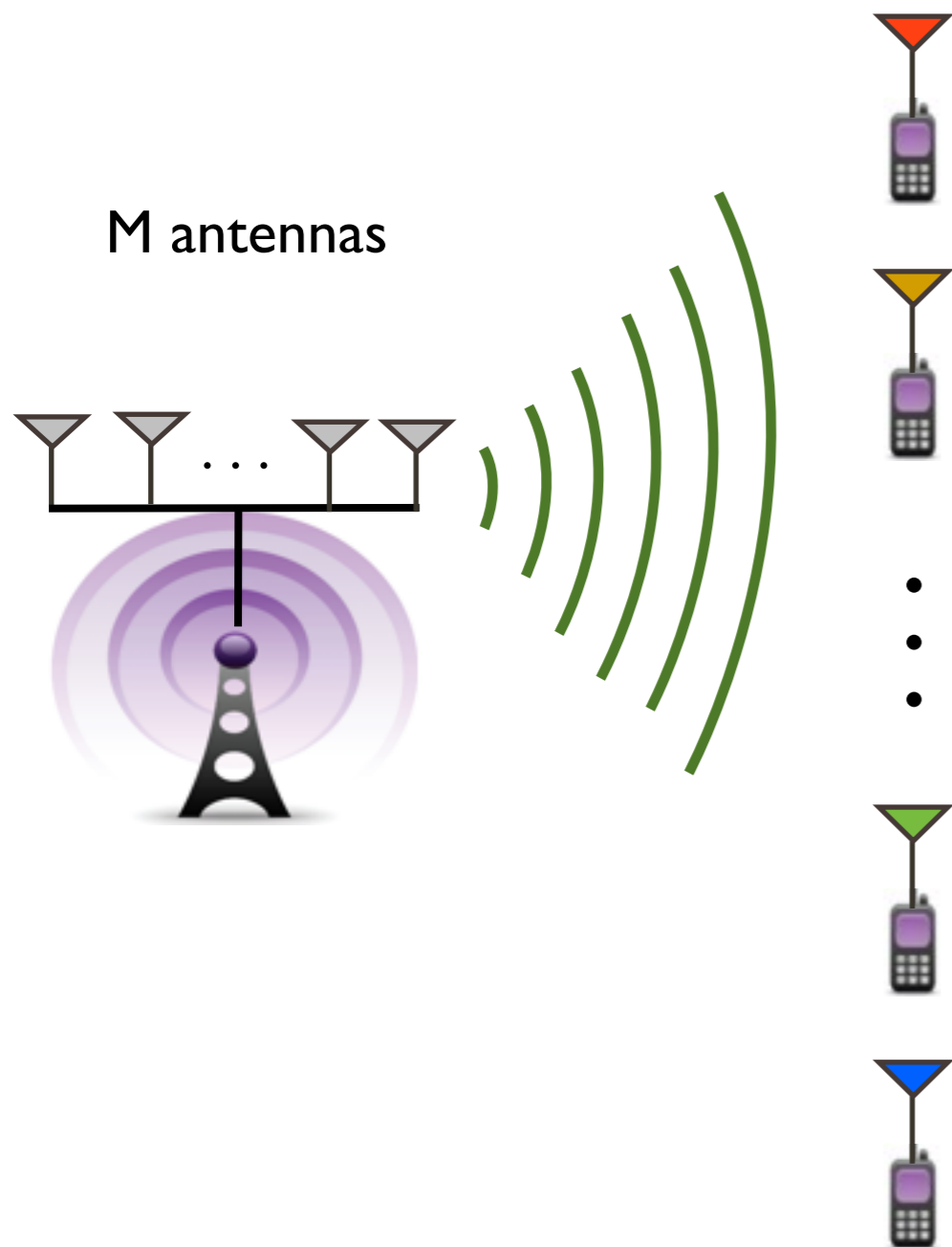

Maximum possible sum DoF = $\min(M, K)$

Minimum **perfect** CSIT to achieve maximum sum DoF:

$$\lambda^*(M, K) = \begin{cases} 0, & \min(M, K) = 1 \\ \frac{\min(M, K)}{K}, & \min(M, K) > 1. \end{cases}$$

Open problems:

What is the minimum perfect CSIT to achieve arbitrary DoF ?

What are the tradeoffs among perfect/delayed/no CSIT ?

Beyond Delayed Channel Knowledge

Beyond Delayed Channel Knowledge

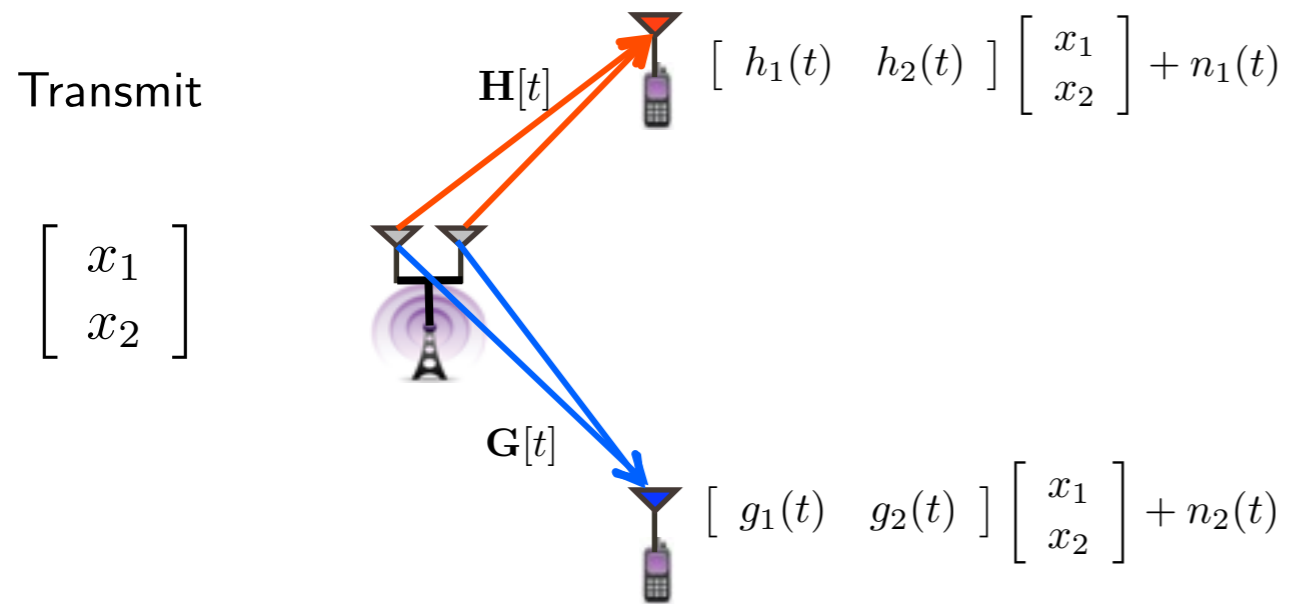

Beyond Delayed Channel Knowledge

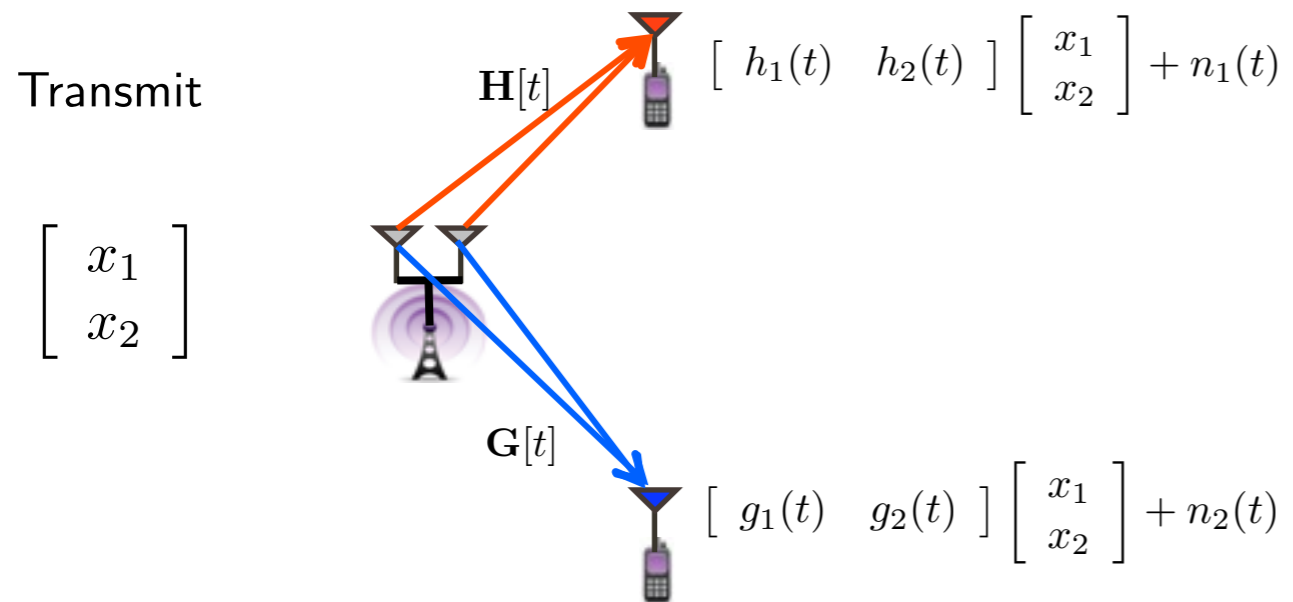

If, in addition to channel state,
transmitter also has outputs ...
does DoF increase?

Beyond Delayed Channel Knowledge

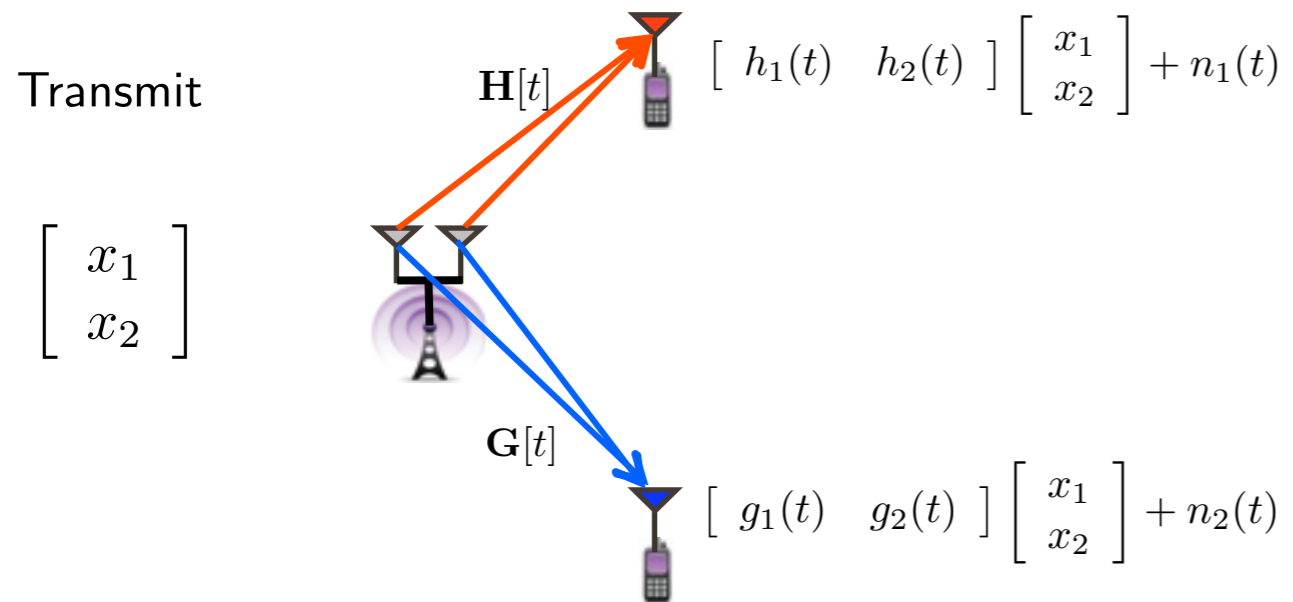

If, in addition to channel state,
transmitter also has outputs ...
does DoF increase?

Answer: **No!**

Output Feedback + Delayed CSI = Delayed CSI

[Maddah-Ali, Tse IT'12]

Beyond Delayed Channel Knowledge

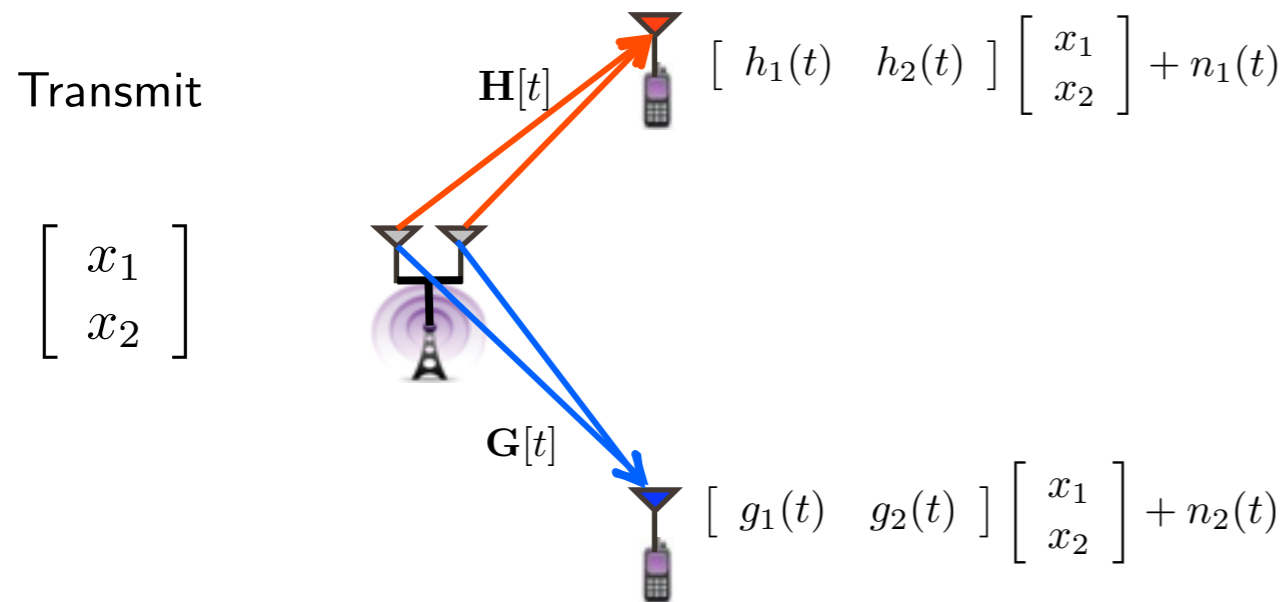

If, in addition to channel state, transmitter also has outputs ...
does DoF increase?

Answer: **No!**

Output Feedback + Delayed CSI = Delayed CSI

[Maddah-Ali, Tse IT'12]

(But for the **MIMO interference channel** the answer is **yes.**)

[Tandon-Mohajer-Poor-Shamai, IT'13]

Summary: MISO Fading Broadcast Channels

- ▶ **Channel state information** via feedback
- ▶ **Retrospective** interference alignment
- ▶ Advantages of **spatio-temporal variability** of channel knowledge

Summary

- Background
 - ✘ Point-to-point channels
 - ✘ Multi-terminal channels
- Static Interference Channels
 - ✘ Why feedback helps
 - ✘ Feedback gain for many-user interference channels
- Fading MISO Broadcast Channels
 - ✘ The effects of channel state feedback
 - ✘ Spatio-temporal variation in channel state feedback